

Supplement

– TO TURNING TOOLS AND ROTATING TOOLS CATALOGUES



General turning	A
Milling	B
Drilling	C
Boring	D
Rotating tool adaptors	E
General information	F

General turning

CoroTurn® Prime

Inserts A2

CoroTurn® TR

Inserts A3

CoroTurn® 107

Inserts A5-A8
External tools A10-A13
Internal tools A14

T-Max® P

Inserts A15-A23

T-Max®

Inserts A24

CoroTurn® XS

Cutting tools A25

Cutting data

A26

For complete assortment, see www.sandvik.coromant.com

CoroTurn® Prime insert for turning

A-type insert

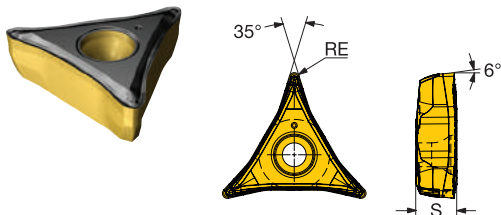

		SSC	S	REEQ	RE	ISO CODE	P	
							4415	4425
Finishing	L5	CP-A	6.00	0.4	0.40	CP-A1104-L5	★	☆
			.236	.016	.016			
	L3W	CP-A	6.00	0.8	0.79	CP-A1108-L5	★	☆
			.236	.031	.031			
	L3	CP-A	6.00	0.8	0.80	CP-A1108-L5W	★	☆
			.236	.031	.031			
L3WX	CP-A	6.00	0.8	0.80	CP-A1108-L3	★	☆	
		.236	.031	.031				

B-type insert

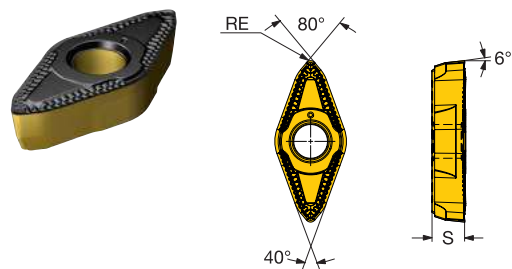

		SSC	S	REEQ	RE	ISO CODE	P	
							4425	
Finishing	L4	CP-B	5.00	0.8	0.80	CP-B1108-L4	★	
			.197	.031	.031			
	L4W	CP-B	5.00	0.8	0.80	CP-B1108-L4W	★	
			.197	.031	.031			
Medium	M5	CP-B	5.00	0.8	0.80	CP-B1108-M5	★	
			.197	.031	.031			
	M5W	CP-B	5.00	0.8	0.80	CP-B1108-M5W	★	
			.197	.031	.031			
	H3W	CP-B	5.00	0.8	0.80	CP-B1108-H3W	★	
			.197	.031	.031			
H3	CP-B	5.00	0.8	0.80	CP-B1108-H3	★		
		.197	.031	.031				

SSC = To correspond with SSC on holder.

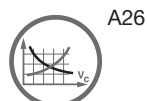

CoroTurn® TR insert for turning

D-style insert (Rhombic 55°)

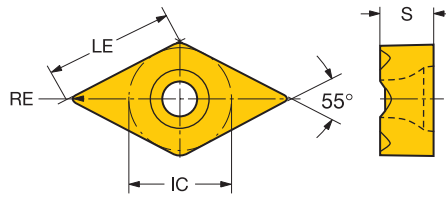
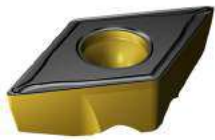

		LE	S	RE	ISO CODE	P		
						4415	4425	
Finishing	F	13	12.6	5.53	0.40	TR-DC1304-F	★	☆
			.496	.218	.016			
			12.2	5.53	0.79	TR-DC1308-F	★	☆
			.480	.218	.031			
Medium	M	13	12.2	5.53	0.79	TR-DC1308-M	☆	★
			.480	.218	.031			
			11.8	5.53	1.19	TR-DC1312-M	☆	★
			.465	.218	.047			

Advanced cutting materials

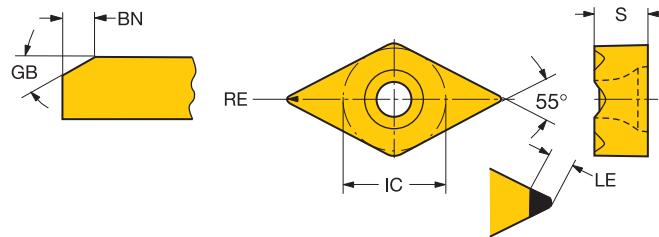
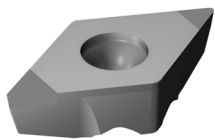

		LE	S	RE	ISO CODE	S		
						7014		
Finishing	EF	13	3.0	5.53	0.79	TR-DC1308EF	★	
			.118	.218	.031			
			2.6	5.53	1.19	TR-DC1312EF	★	
			.104	.218	.047			



A26



F2



CoroTurn® TR insert for turning

V-style insert (Rhombic 35°)

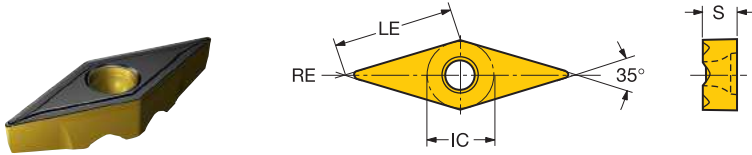

B

		LE	S	RE	ISO CODE	P		
						4415	4425	
Finishing	F	13	12.6	4.53	0.40	TR-VB1304-F	★	☆
			.496	.178	.016			
			12.2	4.53	0.79	TR-VB1308-F	★	☆
			.480	.178	.031			
			11.8	4.53	1.19	TR-VB1312-F	★	☆
		.465	.178	.047				

C

Advanced cutting materials

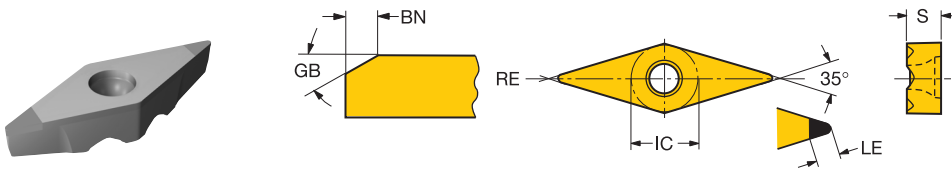

D

		LE	S	RE	ISO CODE	S		
						7014		
Finishing	EF	13	3.0	4.53	0.79	TR-VB1308EF	★	
			.118	.178	.031			
			2.1	4.53	1.19	TR-VB1312EF	★	
			.084	.178	.047			

E

F



CoroTurn® 107 insert for turning

C-style insert (Rhombic 80°)

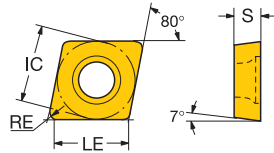
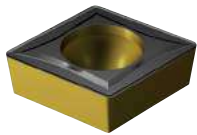

		LE	S	RE	ISO CODE	P		ANSI CODE		
						4415	4425			
Finishing	WF	06 1/4	6.0	2.38	0.40	CCMT 06 02 04-WF	★	☆	CCMT 2(1.5)1-WF	
			.238	.094	.016					
			5.6	2.38	0.79	CCMT 06 02 08-WF	★	☆	CCMT 2(1.5)2-WF	
			.222	.094	.031					
		09 3/8	9.3	3.97	0.40	CCMT 09 T3 04-WF	★	☆	CCMT 3(2.5)1-WF	
			.365	.156	.016					
		8.9	3.97	0.79	CCMT 09 T3 08-WF	★	☆	CCMT 3(2.5)2-WF		
		.349	.156	.031						
		06 1/4	6.2	2.38	0.20	CCMT 06 02 02-PF		★	CCMT 2(1.5)0-PF	
		.246	.094	.008						
		6.0	2.38	0.40	CCMT 06 02 04-PF	★		CCMT 2(1.5)1-PF		
		.238	.094	.016						
	09 3/8	9.3	3.97	0.40	CCMT 09 T3 04-PF	★	☆	CCMT 3(2.5)1-PF		
	.365	.156	.016							
	8.9	3.97	0.79	CCMT 09 T3 08-PF	★	☆	CCMT 3(2.5)2-PF			
	.349	.156	.031							
	12 1/2	12.5	4.76	0.40	CCMT 12 04 04-PF	★	☆	CCMT 431-PF		
	.492	.188	.016							
	06 1/4	6.0	2.38	0.40	CCMT 06 02 04-UF	★	☆	CCMT 2(1.5)1-UF		
	.238	.094	.016							
	09 3/8	9.3	3.97	0.40	CCMT 09 T3 04-UF	★	☆	CCMT 3(2.5)1-UF		
	.365	.156	.016							
Medium	WM	06 1/4	5.6	2.38	0.79	CCMT 06 02 08-WM	☆	★	CCMT 2(1.5)2-WM	
			.222	.094	.031					
		09 3/8	9.3	3.97	0.40	CCMT 09 T3 04-WM	☆	★	CCMT 3(2.5)1-WM	
			.365	.156	.016					
			8.9	3.97	0.79	CCMT 09 T3 08-WM	☆	★	CCMT 3(2.5)2-WM	
			.349	.156	.031					
		12 1/2	12.5	4.76	0.40	CCMT 12 04 04-WM	☆	★	CCMT 431-WM	
		.492	.188	.016						
		12.1	4.76	0.79	CCMT 12 04 08-WM	☆	★	CCMT 432-WM		
		.476	.188	.031						
		06 1/4	6.0	2.38	0.40	CCMT 06 02 04-PM	☆	★	CCMT 2(1.5)1-PM	
		.238	.094	.016						
	5.6	2.38	0.79	CCMT 06 02 08-PM	☆	★	CCMT 2(1.5)2-PM			
	.222	.094	.031							
	09 3/8	9.3	3.97	0.40	CCMT 09 T3 04-PM	☆	★	CCMT 3(2.5)1-PM		
	.365	.156	.016							
	8.9	3.97	0.79	CCMT 09 T3 08-PM	☆	★	CCMT 3(2.5)2-PM			
	.349	.156	.031							
	12 1/2	12.5	4.76	0.40	CCMT 12 04 04-PM	☆	★	CCMT 431-PM		
	.492	.188	.016							
	12.1	4.76	0.79	CCMT 12 04 08-PM	☆	★	CCMT 432-PM			
	.476	.188	.031							
	11.7	4.76	1.19	CCMT 12 04 12-PM	☆	★	CCMT 433-PM			
	.460	.188	.047							
	06 1/4	6.0	2.38	0.40	CCMT 06 02 04-UM	☆	★	CCMT 2(1.5)1-UM		
	.238	.094	.016							
	09 3/8	9.3	3.97	0.40	CCMT 09 T3 04-UM	☆	★	CCMT 3(2.5)1-UM		
	.365	.156	.016							
	8.9	3.97	0.79	CCMT 09 T3 08-UM	☆	★	CCMT 3(2.5)2-UM			
	.349	.156	.031							
	12 1/2	12.1	4.76	0.79	CCMT 12 04 08-UM	☆	★	CCMT 432-UM		
	.476	.188	.031							



A26



F2



CoroTurn® 107 insert for turning

C-style insert (Rhombic 80°)

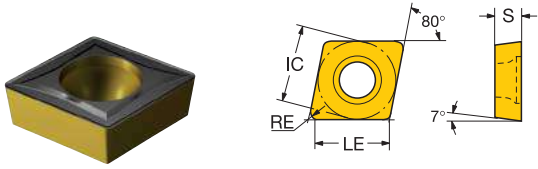

B

		LE	S	RE	ISO CODE	P		ANSI CODE			
						4415	4425				
Roughing	PR	06	1/4	5.6	2.38	0.79	CCMT 06 02 08-PR	☆	★	CCMT 2(1.5)2-PR	
				.222	.094	.031					
		09	3/8	8.9	3.97	0.79	CCMT 09 T3 08-PR	☆	★	CCMT 3(2.5)2-PR	
				.349	.156	.031					
				8.5	3.97	1.19	CCMT 09 T3 12-PR	☆	★	CCMT 3(2.5)3-PR	
				.334	.156	.047					
		UR	12	1/2	12.1	4.76	0.79	CCMT 12 04 08-PR	☆	★	CCMT 432-PR
				.476	.188	.031					
				11.7	4.76	1.19	CCMT 12 04 12-PR	☆	★	CCMT 433-PR	
				.460	.188	.047					
			09	3/8	9.3	3.97	0.40	CCMT 09 T3 04-UR	☆	★	CCMT 3(2.5)1-UR
				.365	.156	.016					
			8.9	3.97	0.79	CCMT 09 T3 08-UR	☆	★	CCMT 3(2.5)2-UR		
			.349	.156	.031						
		12	1/2	12.1	4.76	0.79	CCMT 12 04 08-UR	☆	★	CCMT 432-UR	
			.476	.188	.031						

C

D

E

F

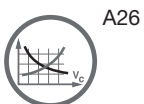

CoroTurn® 107 insert for turning

D-style insert (Rhombic 55°)

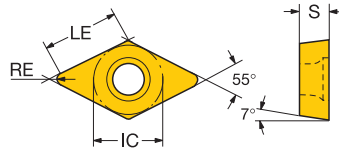
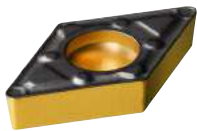

		LE	S	RE	ISO CODE	P		ANSI CODE						
						4415	4425							
Finishing	WF	07	1/4	7.4	2.38	0.40	★	★	DCMX 07 02 04-WF	★	★	DCMX 2(1.5)1-WF		
				.289	.094	.016								
				7.0	2.38	0.79				DCMX 07 02 08-WF	★	★	DCMX 2(1.5)2-WF	
				.274	.094	.031								
		11	3/8	11.2	3.97	0.40				DCMX 11 T3 04-WF	★	★	DCMX 3(2.5)1-WF	
				.442	.156	.016								
			10.8	3.97	0.79				DCMX 11 T3 08-WF	★	★	DCMX 3(2.5)2-WF		
			.426	.156	.031									
		PF	07	1/4	7.4	2.38	0.40	★	★	DCMT 07 02 04-PF	★	★	DCMT 2(1.5)1-PF	
				.289	.094	.016								
				11	3/8	11.2	3.97	0.40			DCMT 11 T3 04-PF	★	★	DCMT 3(2.5)1-PF
				.442	.156	.016								
			10.8	3.97	0.79				DCMT 11 T3 08-PF	★	★	DCMT 3(2.5)2-PF		
			.426	.156	.031									
	UF	07	1/4	7.4	2.38	0.40	★	★	DCMT 07 02 04-UF	★	★	DCMT 2(1.5)1-UF		
			.289	.094	.016									
			11	3/8	11.2	3.97	0.40			DCMT 11 T3 04-UF	★	★	DCMT 3(2.5)1-UF	
			.442	.156	.016									
			10.8	3.97	0.79				DCMT 11 T3 08-UF	★	★	DCMT 3(2.5)2-UF		
			.426	.156	.031									
Medium	WM	11	3/8	11.2	3.97	0.40	★	★	DCMX 11 T3 04-WM	★	★	DCMX 3(2.5)1-WM		
				.442	.156	.016								
				10.8	3.97	0.79				DCMX 11 T3 08-WM	★	★	DCMX 3(2.5)2-WM	
				.426	.156	.031								
			PM	07	1/4	7.4	2.38	0.40	★	★	DCMT 07 02 04-PM	★	★	DCMT 2(1.5)1-PM
					.289	.094	.016							
				7.0	2.38	0.79				DCMT 07 02 08-PM	★	★	DCMT 2(1.5)2-PM	
				.274	.094	.031								
				11	3/8	11.2	3.97	0.40			DCMT 11 T3 04-PM	★	★	DCMT 3(2.5)1-PM
				.442	.156	.016								
			10.8	3.97	0.79				DCMT 11 T3 08-PM	★	★	DCMT 3(2.5)2-PM		
			.426	.156	.031									
		10.4	3.97	1.19				DCMT 11 T3 12-PM	★	★	DCMT 3(2.5)3-PM			
		.411	.156	.047										
Roughing	UM	07	1/4	7.4	2.38	0.40	★	★	DCMT 07 02 04-UM	★	★	DCMT 2(1.5)1-UM		
				.289	.094	.016								
				7.0	2.38	0.79				DCMT 07 02 08-UM	★	★	DCMT 2(1.5)2-UM	
				.274	.094	.031								
				11	3/8	11.2	3.97	0.40			DCMT 11 T3 04-UM	★	★	DCMT 3(2.5)1-UM
				.442	.156	.016								
			10.8	3.97	0.79				DCMT 11 T3 08-UM	★	★	DCMT 3(2.5)2-UM		
			.426	.156	.031									
		PR	11	3/8	10.8	3.97	0.79	★	★	DCMT 11 T3 08-PR	★	★	DCMT 3(2.5)2-PR	
				.426	.156	.031								
				10.4	3.97	1.19				DCMT 11 T3 12-PR	★	★	DCMT 3(2.5)3-PR	
				.411	.156	.047								
	UR		11	3/8	11.2	3.97	0.40	★	★	DCMT 11 T3 04-UR	★	★	DCMT 3(2.5)1-UR	
				.442	.156	.016								
			10.8	3.97	0.79				DCMT 11 T3 08-UR	★	★	DCMT 3(2.5)2-UR		
			.426	.156	.031									
			10.4	3.97	1.19				DCMT 11 T3 12-UR	★	★	DCMT 3(2.5)3-UR		
			.411	.156	.047									

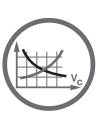

A26



F2



CoroTurn® 107 insert for turning

S-style insert (Square)

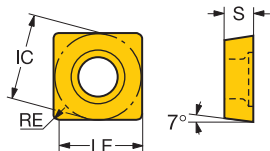
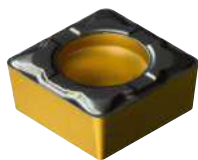

B

					RE	ISO CODE	P		ANSI CODE			
		LE	S	RE			4415	4425				
Finishing	PF	09	3/8	9.1	3.97	0.40	SCMT 09 T3 04-PF	★	☆	SCMT 3(2.5)1-PF		
				.359	.156	.016						
			8.7	3.97	0.79	SCMT 09 T3 08-PF	★	☆	SCMT 3(2.5)2-PF			
			.344	.156	.031							
	UF	09	3/8	8.7	3.97	0.79	SCMT 09 T3 08-UF	★	☆	SCMT 3(2.5)2-UF		
				.344	.156	.031						
Medium	PM	09	3/8	9.1	3.97	0.40	SCMT 09 T3 04-PM	☆	★	SCMT 3(2.5)1-PM		
				.359	.156	.016						
				8.7	3.97	0.79	SCMT 09 T3 08-PM	☆	★	SCMT 3(2.5)2-PM		
				.344	.156	.031						
				12	1/2	12.3	4.76	0.40	SCMT 12 04 04-PM	☆	★	SCMT 431-PM
				.484	.188	.016						
			11.9	4.76	0.79	SCMT 12 04 08-PM	☆	★	SCMT 432-PM			
			.469	.188	.031							
			11.5	4.76	1.19	SCMT 12 04 12-PM	☆	★	SCMT 433-PM			
			.453	.188	.047							
		UM	09	3/8	8.7	3.97	0.79	SCMT 09 T3 08-UM	☆	★	SCMT 3(2.5)2-UM	
				.344	.156	.031						
			12	1/2	11.9	4.76	0.79	SCMT 12 04 08-UM	☆	★	SCMT 432-UM	
			.469	.188	.031							
		11.5	4.76	1.19	SCMT 12 04 12-UM	☆	★	SCMT 433-UM				
		.453	.188	.047								
Roughing	PR	09	3/8	8.7	3.97	0.79	SCMT 09 T3 08-PR	☆	★	SCMT 3(2.5)2-PR		
				.344	.156	.031						
				8.3	3.97	1.19	SCMT 09 T3 12-PR	☆	★	SCMT 3(2.5)3-PR		
				.328	.156	.047						
				12	1/2	11.9	4.76	0.79	SCMT 12 04 08-PR	☆	★	SCMT 432-PR
				.469	.188	.031						
			11.5	4.76	1.19	SCMT 12 04 12-PR	☆	★	SCMT 433-PR			
			.453	.188	.047							
		UR	09	3/8	8.7	3.97	0.79	SCMT 09 T3 08-UR	☆	★	SCMT 3(2.5)2-UR	
				.344	.156	.031						
			12	1/2	11.9	4.76	0.79	SCMT 12 04 08-UR	☆	★	SCMT 432-UR	
			.469	.188	.031							

D

E

F



CoroTurn® 107 insert for turning

R-style insert (Round)

Round inserts with rail interface

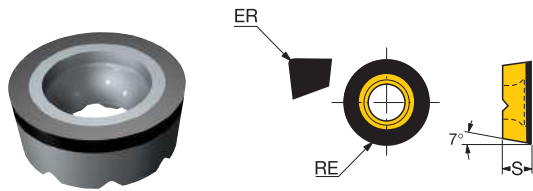

Metric version

		S	RE	ISO CODE	S	
					7014	
Medium	ED	08	3.18	4.00	RCGW0803MTED	★
		10	3.97	5.00	RCGW10T3MTED	★
		12	4.76	6.00	RCGW1204MUED	★

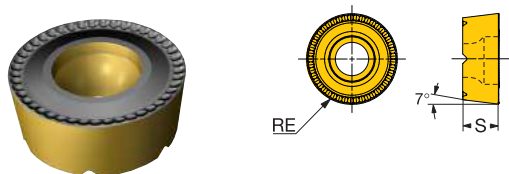

Metric version

		S	RE	ISO CODE	P	M	S	
					4425	1105	2220	1105
Finishing	L3	08	3.18	4.00	RCMT 08 03 MP-L3	★	☆	★
		10	3.97	5.00	RCMT 10 T3 MP-L3	★	☆	★
		12	4.76	6.00	RCMT 12 04 MP-L3	★	☆	★
		16	6.35	8.00	RCMT 16 06 MP-L3	★	☆	★
Medium	M3	08	3.18	4.00	RCMT 08 03 MP-M3	★	☆	★
		10	3.97	5.00	RCMT 10 T3 MP-M3	★	☆	★
		12	4.76	6.00	RCMT 12 04 MP-M3	★	☆	★
		16	6.35	8.00	RCMT 16 06 MP-M3	★	☆	★
Roughing	H7	08	3.18	4.00	RCMT 08 03 MP-H7	★	☆	★
		10	3.97	5.00	RCMT 10 T3 MP-H7	★	☆	★
		12	4.76	6.00	RCMT 12 04 MP-H7	★	☆	★
		16	6.35	8.00	RCMT 16 06 MP-H7	★	☆	★



A26



F2

CoroTurn® 107 cutting unit for turning

Screw clamp design - For inserts with rail interface

Coromant Capto® - Internal coolant supply

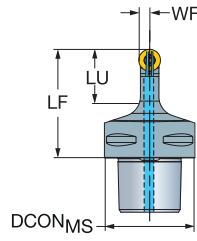
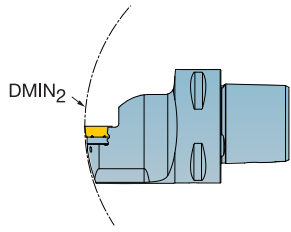

RCMT..MP/MT/MU

		Dimensions, mm, inch														
		CZC _{MS}	DMIN ₂	LU	RMPX	CNSC	Ordering code	DCON _{MS}	WB	LF	WF				MIID	
																08
			6.496	1.102				1.969	.268	2.362	.157	2175				
		C6	190.0	32.0	90°	3	C6-SRDCN-00065-08XC	63	6.8	65.0	4.0	150	1.4	0.89	RCMT 08 03 MP	
			7.480	1.260				2.480	.268	2.559	.157	2175				
		C5	165.0	30.0	90°	3	C5-SRDCN-00060-10XC	50	8.4	60.0	5.0	150	3.0	0.53	RCMT 10 T3 MP	
			6.496	1.181				1.969	.331	2.362	.197	2175				
		C6	190.0	34.0	90°	3	C6-SRDCN-00065-10XC	63	8.4	65.0	5.0	150	3.0	0.89	RCMT 10 T3 MP	
			7.480	1.339				2.480	.331	2.559	.197	2175				
		C5	165.0	30.0	90°	3	C5-SRDCN-00060-12XC	50	10.2	60.0	6.0	150	3.0	0.54	RCMT 12 04 MP	
			6.496	1.181				1.969	.402	2.362	.236	2175				
		C6	190.0	34.0	90°	3	C6-SRDCN-00065-12XC	63	10.2	65.0	6.0	150	3.0	0.91	RCMT 12 04 MP	
			7.480	1.339				2.480	.402	2.559	.236	2175				
		C5	165.0	30.0	90°	3	C5-SRDCN-00060-16XC	50	13.6	60.0	8.0	150	6.4	0.57	RCMT 16 06 MP	
			6.496	1.181				1.969	.535	2.362	.315	2175				
		C6	190.0	34.0	90°	3	C6-SRDCN-00065-16XC	63	13.6	65.0	8.0	150	6.4	0.94	RCMT 16 06 MP	
			7.480	1.339				2.480	.535	2.559	.315	2175				

N - Neutral

		Spare parts					
		CZC _{MS}	Insert screw	Shim	Shim screw	Nozzle	
							08
10	.394	C5-C6	5513 020-09			5691 026-13	
12	.472	C5-C6	5513 020-01	5322 160-01 E7F3	5512 090-01	5691 026-13	
16	.630	C5-C6	5513 020-26	5322 160-02 E7F3	5512 090-06	5691 026-03	

For complete list of spare parts, see www.sandvik.coromant.com



CoroTurn® 107 cutting unit for turning

Screw clamp design - For inserts with rail interface

Coromant Capto® - Internal coolant supply



RCMT..MP/MT/MU

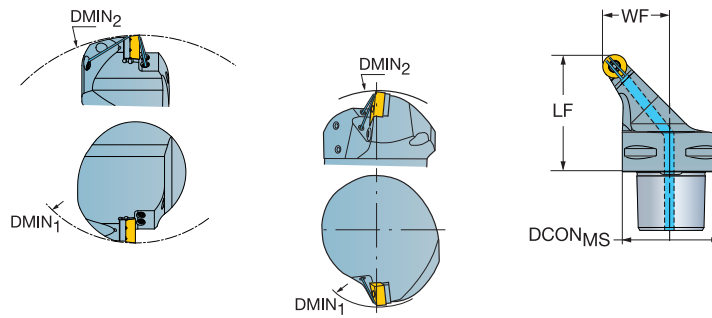

												Dimensions, mm, inch			
		CZC _{MS}	DMIN ₁	DMIN ₂	RMPX	CNCS	Ordering code	DCON _{MS}	LF	WF				MIID	
08	.315	C5	150.0	165.0	45°	3	C5-SRSCR/L-35060-08XC	50	60.0	35.0	150	1.4	0.61	RCMT 08 03 MP	
			5.906	6.496					1.969	2.362	1.378	2175			
		C6	150.0	190.0	45°	3	C6-SRSCR/L-45065-08XC	63	65.0	45.0	150	1.4	1.17	RCMT 08 03 MP	
			5.906	7.480					2.480	2.559	1.772	2175			
10	.394	C5	150.0	165.0	45°	3	C5-SRSCR/L-35060-10XC	50	60.0	35.0	150	3.0	0.62	RCMT 10 T3 MP	
			5.906	6.496					1.969	2.362	1.378	2175			
		C6	150.0	190.0	45°	3	C6-SRSCR/L-45065-10XC	63	65.0	45.0	150	3.0	1.17	RCMT 10 T3 MP	
			5.906	7.480					2.480	2.559	1.772	2175			
12	.472	C5	150.0	165.0	45°	3	C5-SRSCR/L-35060-12XC	50	60.0	35.0	150	3.0	0.63	RCMT 12 04 MP	
			5.906	6.496					1.969	2.362	1.378	2175			
		C6	150.0	190.0	45°	3	C6-SRSCR/L-45065-12XC	63	65.0	45.0	150	3.0	1.18	RCMT 12 04 MP	
			5.906	7.480					2.480	2.559	1.772	2175			
16	.630	C5	150.0	165.0	45°	3	C5-SRSCR/L-35060-16XC	50	60.0	35.0	150	6.4	0.64	RCMT 16 06 MP	
			5.906	6.496					1.969	2.362	1.378	2175			
		C6	150.0	190.0	45°	3	C6-SRSCR/L-45065-16XC	63	65.0	45.0	150	6.4	1.18	RCMT 16 06 MP	
			5.906	7.480					2.480	2.559	1.772	2175			

R = Right hand, L = Left hand

				Spare parts			
		CZC _{MS}	Insert screw	Shim	Shim screw	Nozzle	
10	.394	C5-C6	5513 020-09			5691 026-13	
12	.472	C5-C6	5513 020-01	5322 160-01	E7F3	5512 090-01	5691 026-03
16	.630	C5-C6	5513 020-26	5322 160-02	E7F3	5512 090-06	5691 026-03

For complete list of spare parts, see www.sandvik.coromant.com



CoroTurn® 107 QS shank tool for turning

Screw clamp design - For inserts with rail interface

Precision coolant supply



RCMT..MP/MT/MU

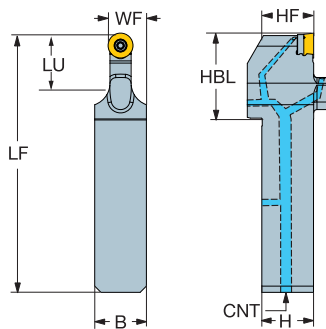

Metric version

	CZC _{MS}	LU	RMPX	OHX	CNSC	Ordering code	Dimensions, mm							BAR	NM	KG	MIID	
							B	H	WB	HBL	LF	WF	HF					CNT
08	20 x 20	20.0	90°	56.0	3	QS-SRDCN-202020-08XC	20.0	20.0	6.8	36.0	105.0	14.0	20.0	G 1/8-28	150	1.4	0.25	RCMT 08 03 MP
	25 x 25	20.0	90°	61.0	3	QS-SRDCN-252520-08XC	25.0	25.0	6.8	36.0	120.0	16.5	25.0	G 1/8-28	150	1.4	0.46	RCMT 08 03 MP
	25 x 25	40.0	90°	81.0	3	QS-SRDCN-252540-08XC	25.0	25.0	6.8	56.0	140.0	16.5	25.0	G 1/8-28	150	1.4	0.50	RCMT 08 03 MP
10	20 x 20	25.0	90°	60.0	3	QS-SRDCN-202025-10XC	20.0	20.0	8.4	40.0	109.0	15.0	20.0	G 1/8-28	150	3.0	0.27	RCMT 10 T3 MP
	25 x 25	25.0	90°	65.0	3	QS-SRDCN-252525-10XC	25.0	25.0	8.4	40.0	124.0	17.5	25.0	G 1/8-28	150	3.0	0.48	RCMT 10 T3 MP
	25 x 25	40.0	90°	80.0	3	QS-SRDCN-252540-10XC	25.0	25.0	8.4	55.0	139.0	17.5	25.0	G 1/8-28	150	3.0	0.52	RCMT 10 T3 MP
12	20 x 20	25.0	90°	58.0	3	QS-SRDCN-202025-12XC	20.0	20.0	10.2	38.0	107.0	16.0	20.0	G 1/8-28	150	3.0	0.27	RCMT 12 04 MP
	25 x 25	28.0	90°	66.0	3	QS-SRDCN-252528-12XC	25.0	25.0	10.2	41.0	125.0	18.5	25.0	G 1/8-28	150	3.0	0.49	RCMT 12 04 MP
	25 x 25	40.0	90°	78.0	3	QS-SRDCN-252540-12XC	25.0	25.0	10.2	53.0	137.0	20.5	25.0	G 1/8-28	150	3.0	0.52	RCMT 12 04 MP
16	25 x 25	35.0	90°	70.0	3	QS-SRDCN-252535-16XC	25.0	25.0	13.6	45.0	129.0	20.5	25.0	G 1/8-28	150	6.4	0.50	RCMT 16 06 MP

Inch version

	CZC _{MS}	LU	RMPX	OHX	CNSC	Ordering code	Dimensions, inch							PSI	FT/LBS	LBS	MIID	
							B	H	WB	HBL	LF	WF	HF					CNT
.315	3/4 x 3/4	1.000	90°	2.125	3	QS-SRDCN-12-20-08XC	.750	.750	.268	1.375	4.092	.531	.750	G 1/8-28	2175	1.0	0.494	RCMT 08 03 MP
	1 x 1	.750	90°	2.375	3	QS-SRDCN-16-20-08XC	1.000	1.000	.268	1.375	4.682	.656	1.000	G 1/8-28	2175	1.0	1.045	RCMT 08 03 MP
	1 x 1	1.500	90°	3.125	3	QS-SRDCN-16-40-08XC	1.000	1.000	.268	2.125	5.432	.656	1.000	G 1/8-28	2175	1.0	1.120	RCMT 08 03 MP
.394	3/4 x 3/4	1.000	90°	2.375	3	QS-SRDCN-12-25-10XC	.750	.750	.331	1.625	4.342	.570	.750	G 1/8-28	2175	2.2	0.545	RCMT 10 T3 MP
	1 x 1	1.000	90°	2.625	3	QS-SRDCN-16-25-10XC	1.000	1.000	.331	1.625	4.932	.695	1.000	G 1/8-28	2175	2.2	1.111	RCMT 10 T3 MP
	1 x 1	1.500	90°	3.125	3	QS-SRDCN-16-40-10XC	1.000	1.000	.331	2.125	5.432	.695	1.000	G 1/8-28	2175	2.2	1.175	RCMT 10 T3 MP
.472	3/4 x 3/4	1.000	90°	2.250	3	QS-SRDCN-12-25-12XC	.750	.750	.402	1.500	4.217	.610	.750	G 1/8-28	2175	2.2	0.529	RCMT 12 04 MP
	1 x 1	1.125	90°	2.625	3	QS-SRDCN-16-28-12XC	1.000	1.000	.402	1.625	4.932	.735	1.000	G 1/8-28	2175	2.2	1.102	RCMT 12 04 MP
	1 x 1	1.500	90°	3.125	3	QS-SRDCN-16-40-12XC	1.000	1.000	.402	2.125	5.432	.735	1.000	G 1/8-28	2175	2.2	1.206	RCMT 12 04 MP
.630	1 x 1	1.375	90°	2.750	3	QS-SRDCN-16-35-16XC	1.000	1.000	.535	1.750	5.057	.813	1.000	G 1/8-28	2175	4.7	1.124	RCMT 16 06 MP

R = Right hand, L = Left hand

Spare parts									
		CZC _{MS}	Insert screw	Shim	Shim screw	Nozzle	Screw	Screw	Screw
08	.315	20 x 20-25 x 25	5513 020-04			5691 026-23	5512 104-01	3214 012-01	3214 013-01
10	.394	20 x 20-25 x 25	5513 020-09			5691 026-13	5512 104-01	3214 012-01	3214 013-01
12	.472	20 x 20-25 x 25	5513 020-01	5322 160-01	E7F3	5512 090-01	5512 104-01	3214 012-01	3214 013-01
16	.630	25 x 25	5513 020-26	5322 160-02	E7F3	5512 090-06	5512 104-01	3214 012-01	3214 013-01

For complete list of spare parts, see www.sandvik.coromant.com



A9



F2



F5

CoroTurn® 107 QS shank tool for turning

Screw clamp design - For inserts with rail interface

Precision coolant supply



RCMT..MP/MT/MU

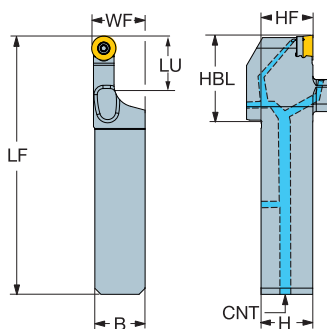

Metric version

CZC _{MS}	LU	RMPX	OHX	CNSC	Ordering code	Dimensions, mm										BAR	NM	KG	MIID
						B	H	WB	HBL	LF	WF	HF	CNT						
08	20 x 20	20.0	90°	59.0	3	QS-SRDRCR/L-202020-08XC	20.0	20.0	6.8	39.0	108.0	21.0	20.0	G 1/8-28	150	1.4	0.26	RCMT 08 03 MP	
	25 x 25	20.0	90°	64.0	3	QS-SRDRCR/L-252520-08XC	25.0	25.0	6.8	39.0	123.0	26.0	25.0	G 1/8-28	150	1.4	0.47	RCMT 08 03 MP	
10	20 x 20	25.0	90°	63.0	3	QS-SRDRCR/L-202025-10XC	20.0	20.0	8.4	43.0	112.0	21.5	20.0	G 1/8-28	150	3.0	0.28	RCMT 10 T3 MP	
	25 x 25	25.0	90°	68.0	3	QS-SRDRCR/L-252525-10XC	25.0	25.0	8.4	43.0	127.0	26.5	25.0	G 1/8-28	150	3.0	0.49	RCMT 10 T3 MP	
12	20 x 20	25.0	90°	60.0	3	QS-SRDRCR/L-202025-12XC	20.0	20.0	10.2	40.0	109.0	21.5	20.0	G 1/8-28	150	3.0	0.27	RCMT 12 04 MP	
	25 x 25	28.0	90°	69.0	3	QS-SRDRCR/L-252528-12XC	25.0	25.0	10.2	44.0	128.0	26.5	25.0	G 1/8-28	150	3.0	0.50	RCMT 12 04 MP	
16	25 x 25	35.0	90°	71.0	3	QS-SRDRCR/L-252535-16XC	25.0	25.0	13.6	46.0	130.0	26.5	25.0	G 1/8-28	150	6.4	0.50	RCMT 16 06 MP	

Inch version

CZC _{MS}	LU	RMPX	OHX	CNSC	Ordering code	Dimensions, inch										PSI	FT/LBS	LBS	MIID
						B	H	WB	HBL	LF	WF	HF	CNT						
.315	3/4 x 3/4	.750	90°	2.250	3	QS-SRDRCR/L-12-20-08XC	.750	.750	.268	1.500	4.217	.781	.750	G 1/8-28	2175	1.0	0.509	RCMT 08 03 MP	
	1 x 1	.750	90°	2.500	3	QS-SRDRCR/L-16-20-08XC	1.000	1.000	.268	1.500	4.807	1.031	1.000	G 1/8-28	2175	1.0	1.067	RCMT 08 03 MP	
.394	3/4 x 3/4	1.000	90°	2.500	3	QS-SRDRCR/L-12-25-10XC	.750	.750	.331	1.750	4.467	.813	.750	G 1/8-28	2175	2.2	0.564	RCMT 10 T3 MP	
	1 x 1	1.000	90°	2.750	3	QS-SRDRCR/L-16-25-10XC	1.000	1.000	.331	1.750	5.057	1.063	1.000	G 1/8-28	2175	2.2	1.140	RCMT 10 T3 MP	
.472	3/4 x 3/4	1.000	90°	2.375	3	QS-SRDRCR/L-12-25-12XC	.750	.750	.402	1.625	4.342	.813	.750	G 1/8-28	2175	2.2	0.551	RCMT 12 04 MP	
	1 x 1	1.125	90°	2.750	3	QS-SRDRCR/L-16-28-12XC	1.000	1.000	.402	1.750	5.057	1.063	1.000	G 1/8-28	2175	2.2	1.133	RCMT 12 04 MP	
.630	1 x 1	1.375	90°	2.875	3	QS-SRDRCR/L-16-35-16XC	1.000	1.000	.535	1.875	5.182	1.063	1.000	G 1/8-28	2175	4.7	1.155	RCMT 16 06 MP	

R = Right hand, L = Left hand

Spare parts									
CZC _{MS}	Insert screw	Shim	Shim screw	Nozzle	Screw	Screw	Screw		
08	.315	20 x 20-25 x 25	5513 020-04						
10	.394	20 x 20-25 x 25	5513 020-09						
12	.472	20 x 20-25 x 25	5513 020-01	5322 160-01 E7F3	5512 090-01	5691 026-13	5512 104-01	3214 012-01	3214 013-01
16	.630	25 x 25	5513 020-26	5322 160-02 E7F3	5512 090-06	5691 026-03	5512 104-01	3214 012-01	3214 013-01

For complete list of spare parts, see www.sandvik.coromant.com



A

CoroTurn® 107 head for turning

Screw clamp design - For inserts with rail interface

CoroTurn® SL70 - Precision coolant supply

ENG

B



RCMT..MP/MT/MU

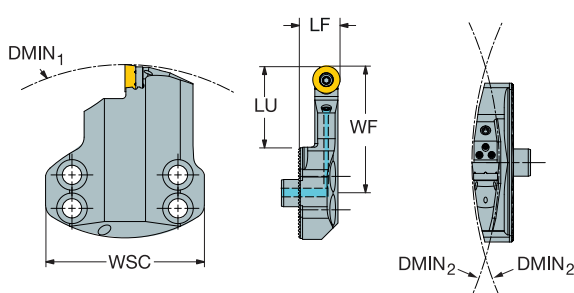

C

		Dimensions, mm, inch														
WB	LF	WF	WSC	BAR PSI	NM	KG						MIID				
							CZC _{MS}	DMIN ₁	DMIN ₂	LU	RMPX		CNSC	Ordering code		
10	.394	70	120.0	250.0	35.0	90°	1	SL70-SRDCL/L-35-10XC	8.4	17.0	56.0	70.0	70	3.0	0.27	RCMT 10 T3 MP
			4.724	9.843	1.378				.331	.669	2.205	2.756	1015			
12	.472	70	120.0	300.0	35.0	90°	1	SL70-SRDCL/L-35-12XC	10.2	18.0	56.0	70.0	70	3.0	0.30	RCMT 12 04 MP
			4.724	11.811	1.378				.402	.709	2.205	2.756	1015			
		70	120.0	260.0	50.0	90°	1	SL70-SRDCL/L-50-12XC	10.2	18.0	71.0	70.0	70	3.0	0.35	RCMT 12 04 MP
			4.724	10.236	1.969				.402	.709	2.795	2.756	1015			
		70	120.0	260.0	75.0	90°	1	SL70-SRDCL/L-75-12XC	10.2	18.0	96.0	70.0	70	3.0	0.44	RCMT 12 04 MP
			4.724	10.236	2.953				.402	.709	3.780	2.756	1015			

R = Right hand, L = Left hand

D

		Spare parts					
WB	CZC _{MS}	Insert screw	Shim	Shim screw	Nozzle	Locating tube	
							10
12	.472	70	5513 020-01	5322 160-01 E7F3	5512 090-01	5691 026-13	5552 058-04

For complete list of spare parts, see www.sandvik.coromant.com

E

F



A9



F2



F5

T-Max® P insert for turning

C-style insert (Rhombic 80°)

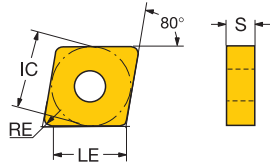
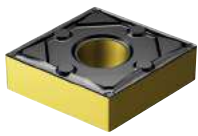

		IC	LE	S	RE	ISO CODE	P		ANSI CODE		
							4115	4425			
Finishing	WF	12	1/2	12.5	4.76	0.40	CNMG 12 04 04-WF	★	☆	CNMG 431-WF	
				.492	.188	.016					
				12.1	4.76	0.79	CNMG 12 04 08-WF	★	☆	CNMG 432-WF	
				.476	.188	.031					
			11.7	4.76	1.19	CNMG 12 04 12-WF	★	☆	CNMG 433-WF		
			.460	.188	.047						
	PF	09	3/8	9.3	3.18	0.40	CNMG 09 03 04-PF	★	☆	CNMG 321-PF	
				.365	.125	.016					
				8.9	3.18	0.79	CNMG 09 03 08-PF	★	☆	CNMG 322-PF	
				.349	.125	.031					
			12	1/2	12.5	4.76	0.40	CNMG 12 04 04-PF	★	☆	CNMG 431-PF
			.492	.188	.016						
		12.1	4.76	0.79	CNMG 12 04 08-PF	★	☆	CNMG 432-PF			
		.476	.188	.031							
		11.7	4.76	1.19	CNMG 12 04 12-PF	★	☆	CNMG 433-PF			
		.460	.188	.047							
LC	12	1/2	12.5	4.76	0.40	CNMG 12 04 04-LC	★	☆	CNMG 431-LC		
			.492	.188	.016						
			12.1	4.76	0.79	CNMG 12 04 08-LC	★	☆	CNMG 432-LC		
		.476	.188	.031							
WL	12	1/2	12.5	4.76	0.40	CNMG 12 04 04-WL	★	☆	CNMG 431-WL		
			.492	.188	.016						
			12.1	4.76	0.79	CNMG 12 04 08-WL	★	☆	CNMG 432-WL		
		.476	.188	.031							
XF	12	1/2	12.5	4.76	0.40	CNMG 12 04 04-XF	★	☆	CNMG 431-XF		
			.492	.188	.016						
			12.1	4.76	0.79	CNMG 12 04 08-XF	★	☆	CNMG 432-XF		
		.476	.188	.031							
Medium	WM	12	1/2	12.1	4.76	0.79	CNMG 12 04 08-WM	☆	★	CNMG 432-WM	
				.476	.188	.031					
				11.7	4.76	1.19	CNMG 12 04 12-WM	☆	★	CNMG 433-WM	
				.460	.188	.047					
			16	5/8	14.9	6.35	1.19	CNMG 16 06 12-WM	☆	★	CNMG 543-WM
			.587	.250	.047						
	WMX	12	1/2	12.1	4.76	0.79	CNMG 12 04 08-WMX	☆	★	CNMG 432-WMX	
				.476	.188	.031					
				11.7	4.76	1.19	CNMG 12 04 12-WMX	☆	★	CNMG 433-WMX	
				.460	.188	.047					
			16	5/8	15.3	6.35	0.79	CNMG 16 06 08-WMX	☆	★	CNMG 542-WMX
			.603	.250	.031						
		14.9	6.35	1.19	CNMG 16 06 12-WMX	☆	★	CNMG 543-WMX			
		.587	.250	.047							



A26



F2

T-Max® P insert for turning

C-style insert (Rhombic 80°)

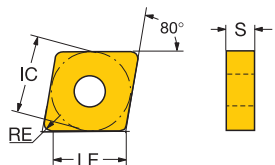
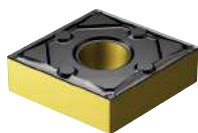

B

C

D

E

F

					RE	ISO CODE	P		ANSI CODE	
		LE	S	RE			4415	4425		
PM	09	3/8	9.3	3.18	0.40	CNMG 09 03 04-PM	☆	★	CNMG 321-PM	
			<i>.365</i>	<i>.125</i>	<i>.016</i>					
			8.9	3.18	0.79	CNMG 09 03 08-PM	☆	★	CNMG 322-PM	
		<i>.349</i>	<i>.125</i>	<i>.031</i>						
	12	1/2	12.5	4.76	0.40	CNMG 12 04 04-PM	☆	★	CNMG 431-PM	
			<i>.492</i>	<i>.188</i>	<i>.016</i>					
			12.1	4.76	0.79	CNMG 12 04 08-PM	☆	★	CNMG 432-PM	
			<i>.476</i>	<i>.188</i>	<i>.031</i>					
			11.7	4.76	1.19	CNMG 12 04 12-PM	☆	★	CNMG 433-PM	
			<i>.460</i>	<i>.188</i>	<i>.047</i>					
	16	5/8	15.3	6.35	0.79	CNMG 16 06 08-PM	☆	★	CNMG 542-PM	
			<i>.603</i>	<i>.250</i>	<i>.031</i>					
			14.9	6.35	1.19	CNMG 16 06 12-PM	☆	★	CNMG 543-PM	
			<i>.587</i>	<i>.250</i>	<i>.047</i>					
			14.5	6.35	1.59	CNMG 16 06 16-PM	☆	★	CNMG 544-PM	
			<i>.572</i>	<i>.250</i>	<i>.063</i>					
	19	3/4	18.5	6.35	0.79	CNMG 19 06 08-PM	☆	★	CNMG 642-PM	
			<i>.730</i>	<i>.250</i>	<i>.031</i>					
18.1			6.35	1.19	CNMG 19 06 12-PM	☆	★	CNMG 643-PM		
		<i>.714</i>	<i>.250</i>	<i>.047</i>						
		17.7	6.35	1.59	CNMG 19 06 16-PM	☆	★	CNMG 644-PM		
		<i>.699</i>	<i>.250</i>	<i>.063</i>						
Medium	09	3/8	9.3	3.18	0.40	CNMG 09 03 04-QM	☆	★	CNMG 321-QM	
			<i>.365</i>	<i>.125</i>	<i>.016</i>					
			8.9	3.18	0.79	CNMG 09 03 08-QM	☆	★	CNMG 322-QM	
		<i>.349</i>	<i>.125</i>	<i>.031</i>						
	12	1/2	12.5	4.76	0.40	CNMG 12 04 04-QM	☆	★	CNMG 431-QM	
			<i>.492</i>	<i>.188</i>	<i>.016</i>					
			12.1	4.76	0.79	CNMG 12 04 08-QM	☆	★	CNMG 432-QM	
			<i>.476</i>	<i>.188</i>	<i>.031</i>					
			11.7	4.76	1.19	CNMG 12 04 12-QM	☆	★	CNMG 433-QM	
			<i>.460</i>	<i>.188</i>	<i>.047</i>					
	16	5/8	15.3	6.35	0.79	CNMG 16 06 04-QM	☆	★	CNMG 541-QM	
			<i>.619</i>	<i>.250</i>	<i>.016</i>					
			15.3	6.35	0.79	CNMG 16 06 08-QM	☆	★	CNMG 542-QM	
			<i>.603</i>	<i>.250</i>	<i>.031</i>					
			14.9	6.35	1.19	CNMG 16 06 12-QM	☆	★	CNMG 543-QM	
			<i>.587</i>	<i>.250</i>	<i>.047</i>					
	19	3/4	18.5	6.35	0.79	CNMG 19 06 08-QM	☆	★	CNMG 642-QM	
			<i>.730</i>	<i>.250</i>	<i>.031</i>					
18.1			6.35	1.19	CNMG 19 06 12-QM	☆	★	CNMG 643-QM		
		<i>.714</i>	<i>.250</i>	<i>.047</i>						
		17.7	6.35	1.59	CNMG 19 06 16-QM	☆	★	CNMG 644-QM		
		<i>.699</i>	<i>.250</i>	<i>.063</i>						
XM	12	1/2	12.5	4.76	0.40	CNMG 12 04 04-XM		★	CNMG 431-XM	
			<i>.492</i>	<i>.188</i>	<i>.016</i>					
			12.1	4.76	0.79	CNMG 12 04 08-XM	☆	★	CNMG 432-XM	
		<i>.476</i>	<i>.188</i>	<i>.031</i>						
		11.7	4.76	1.19	CNMG 12 04 12-XM	☆	★	CNMG 433-XM		
		<i>.460</i>	<i>.188</i>	<i>.047</i>						



A26



F2

T-Max® P insert for turning

C-style insert (Rhombic 80°)

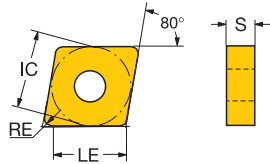
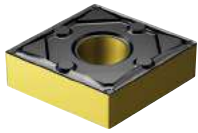

		IC	LE	S	RE	ISO CODE	P		ANSI CODE
							4415	4425	
Roughing	PR	12 1/2	12.1	4.76	0.79	CNMG 12 04 08-PR	☆	★	CNMG 432-PR
			.476	.188	.031				
			11.7	4.76	1.19	CNMG 12 04 12-PR	☆	★	CNMG 433-PR
			.460	.188	.047				
		11.3	4.76	1.59	CNMG 12 04 16-PR	☆	★	CNMG 434-PR	
		.445	.188	.063					
		16 5/8	14.9	6.35	1.19	CNMG 16 06 12-PR	☆	★	CNMG 543-PR
			.587	.250	.047				
			14.5	6.35	1.59	CNMG 16 06 16-PR	☆	★	CNMG 544-PR
			.572	.250	.063				
		19 3/4	13.7	6.35	2.38	CNMG 16 06 24-PR	☆	★	CNMG 546-PR
			.540	.250	.094				
	18.5		6.35	0.79	CNMG 19 06 08-PR	☆	★	CNMG 642-PR	
	.730		.250	.031					
		18.1	6.35	1.19	CNMG 19 06 12-PR	☆	★	CNMG 643-PR	
		.714	.250	.047					
		17.7	6.35	1.59	CNMG 19 06 16-PR	☆	★	CNMG 644-PR	
		.699	.250	.063					
		16.9	6.35	2.38	CNMG 19 06 24-PR	☆	★	CNMG 646-PR	
		.667	.250	.094					
		12 1/2	12.1	4.76	0.79	CNMM 12 04 08-PR	☆	★	CNMM 432-PR
			.476	.188	.031				
	11.7		4.76	1.19	CNMM 12 04 12-PR	☆	★	CNMM 433-PR	
	.460		.188	.047					
	11.3	4.76	1.59	CNMM 12 04 16-PR	☆	★	CNMM 434-PR		
	.445	.188	.063						
	16 5/8	15.3	6.35	0.79	CNMM 16 06 08-PR	☆	★	CNMM 542-PR	
		.603	.250	.031					
14.9		6.35	1.19	CNMM 16 06 12-PR	☆	★	CNMM 543-PR		
.587		.250	.047						
	14.5	6.35	1.59	CNMM 16 06 16-PR	☆	★	CNMM 544-PR		
	.572	.250	.063						
	19 3/4	18.1	6.35	1.19	CNMM 19 06 12-PR	☆	★	CNMM 643-PR	
		.714	.250	.047					
17.7		6.35	1.59	CNMM 19 06 16-PR	☆	★	CNMM 644-PR		
.699		.250	.063						
	16.9	6.35	2.38	CNMM 19 06 24-PR	☆	★	CNMM 646-PR		
	.667	.250	.094						
	12 1/2	12.1	4.76	0.79	CNMM 12 04 08-QR	☆	★	CNMM 432-QR	
		.476	.188	.031					
11.7		4.76	1.19	CNMM 12 04 12-QR	☆	★	CNMM 433-QR		
.460		.188	.047						
	11.3	4.76	1.59	CNMM 12 04 16-QR	☆	★	CNMM 434-QR		
	.445	.188	.063						
	16 5/8	14.9	6.35	1.19	CNMM 16 06 12-QR	☆	★	CNMM 543-QR	
		.587	.250	.047					
14.5		6.35	1.59	CNMM 16 06 16-QR	☆	★	CNMM 544-QR		
.572		.250	.063						
	13.7	6.35	2.38	CNMM 16 06 24-QR	☆	★	CNMM 546-QR		
	.540	.250	.094						
	19 3/4	18.1	6.35	1.19	CNMM 19 06 12-QR	☆	★	CNMM 643-QR	
		.714	.250	.047					
17.7		6.35	1.59	CNMM 19 06 16-QR	☆	★	CNMM 644-QR		
.699		.250	.063						
	16.9	6.35	2.38	CNMM 19 06 24-QR	☆	★	CNMM 646-QR		
	.667	.250	.094						

B

C

D

E

F



A26



F2



T-Max® P insert for turning

C-style insert (Rhombic 80°)

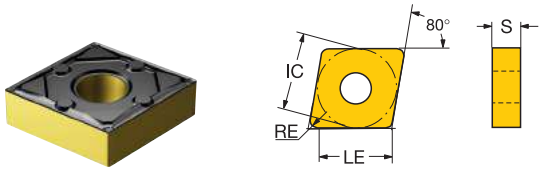

B

								P			
		IC		LE	S	RE	ISO CODE	4415	4425	ANSI CODE	
Roughing	XMR	12	1/2	12.1	4.76	0.79	CNMG 12 04 08-XMR	★	★	CNMG 432-XMR	
				.476	.188	.031					
				11.7	4.76	1.19	CNMG 12 04 12-XMR	★	★	CNMG 433-XMR	
				.480	.188	.047					
				11.3	4.76	1.59	CNMG 12 04 16-XMR	★	★	CNMG 434-XMR	
		.445	.188	.063							

C

D

E

F

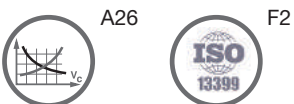

T-Max® P insert for turning

D-style insert (Rhombic 55°)

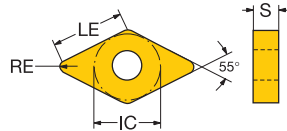
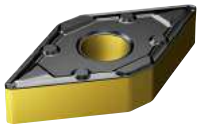

		LE	S	RE	ISO CODE	P		ANSI CODE		
						4415	4425			
Finishing	WF	11 3/8	11.2	4.76	0.40	DNMX 11 04 04-WF	★	☆	DNMX 331-WF	
				10.8	4.76	0.79	DNMX 11 04 08-WF	★	☆	DNMX 332-WF
			15 1/2	15.1	4.76	0.40	DNMX 15 04 04-WF	★	☆	DNMX 431-WF
				14.7	4.76	0.79	DNMX 15 04 08-WF	★	☆	DNMX 432-WF
				15.1	6.35	0.40	DNMX 15 06 04-WF	★	☆	DNMX 441-WF
				14.7	6.35	0.79	DNMX 15 06 08-WF	★	☆	DNMX 442-WF
			14.3	6.35	1.19	DNMX 15 06 12-WF	★	☆	DNMX 443-WF	
			11 3/8	11.2	4.76	0.40	DNMG 11 04 04-PF	★	☆	DNMG 331-PF
			10.8	4.76	0.79	DNMG 11 04 08-PF	★	☆	DNMG 332-PF	
			10.4	4.76	1.19	DNMG 11 04 12-PF	★	☆	DNMG 333-PF	
		15 1/2	15.1	4.76	0.40	DNMG 15 04 04-PF	★	☆	DNMG 431-PF	
			14.7	4.76	0.79	DNMG 15 04 08-PF	★	☆	DNMG 432-PF	
			14.3	4.76	1.19	DNMG 15 04 12-PF	★	☆	DNMG 433-PF	
			15.1	6.35	0.40	DNMG 15 06 04-PF	★	☆	DNMG 441-PF	
		14.7	6.35	0.79	DNMG 15 06 08-PF	★	☆	DNMG 442-PF		
		14.3	6.35	1.19	DNMG 15 06 12-PF	★	☆	DNMG 443-PF		
	LC	11 3/8	10.8	4.76	0.79	DNMG 11 04 08-LC	★	☆	DNMG 332-LC	
		15 1/2	15.1	4.76	0.40	DNMG 15 04 04-LC	★	☆	DNMG 431-LC	
		14.7	4.76	0.79	DNMG 15 04 08-LC	★	☆	DNMG 432-LC		
		14.7	6.35	0.79	DNMG 15 06 08-LC	★	☆	DNMG 442-LC		
	K	15 1/2	15.1	6.35	0.40	DNMG 15 06 04R/L-K	★	☆	DNMG 441L-K	
		14.7	6.35	0.79	DNMG 15 06 08R/L-K	★	☆	DNMG 442L-K		
	XF	15 1/2	14.7	6.35	0.79	DNMG 15 06 08-XF	★	☆	DNMG 442-XF	



A26



F2

T-Max® P insert for turning

D-style insert (Rhombic 55°)

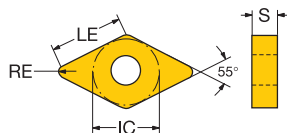
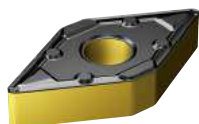

B

		LE	S	RE	ISO CODE	P		ANSI CODE		
						4415	4425			
WM	11 3/8	10.8	4.76	0.79	DNMX 11 04 08-WM	☆	★	DNMX 332-WM		
		.426	.188	.031						
		10.4	4.76	1.19	DNMX 11 04 12-WM	☆	★	DNMX 333-WM		
		.411	.188	.047						
		15 1/2	14.7	4.76	0.79	DNMX 15 04 08-WM	☆	★	DNMX 432-WM	
		.579	.188	.031						
	WMX	15 1/2	14.7	6.35	0.79	DNMX 15 06 08-WM	☆	★	DNMX 442-WM	
			.579	.250	.031					
			14.3	6.35	1.19	DNMX 15 06 12-WM	☆	★	DNMX 443-WM	
			.563	.250	.047					
			13.9	6.35	1.59	DNMX 15 06 16-WM	☆	★	DNMX 444-WM	
			.547	.250	.063					
Medium	WMX	14.7	4.76	1.19	DNMX 15 04 12-WMX	☆	★	DNMX 433-WMX		
		.563	.188	.047						
		14.7	6.35	0.79	DNMX 15 06 08-WMX	☆	★	DNMX 442-WMX		
		.579	.250	.031						
		14.3	6.35	1.19	DNMX 15 06 12-WMX	☆	★	DNMX 443-WMX		
		.563	.250	.047						
		13.9	6.35	1.59	DNMX 15 06 16-WMX	☆	★	DNMX 444-WMX		
		.547	.250	.063						
		PM	11 3/8	11.2	4.76	0.40	DNMG 11 04 04-PM	☆	★	DNMG 331-PM
				.442	.188	.016				
				10.8	4.76	0.79	DNMG 11 04 08-PM	☆	★	DNMG 332-PM
				.426	.188	.031				
	10.4			4.76	1.19	DNMG 11 04 12-PM	☆	★	DNMG 333-PM	
	.411			.188	.047					
	15 1/2		15.1	4.76	0.40	DNMG 15 04 04-PM	☆	★	DNMG 431-PM	
			.595	.188	.016					
			14.7	4.76	0.79	DNMG 15 04 08-PM	☆	★	DNMG 432-PM	
			.579	.188	.031					
			14.3	4.76	1.19	DNMG 15 04 12-PM	☆	★	DNMG 433-PM	
			.563	.188	.047					
	QM	11 3/8	10.4	4.76	1.19	DNMG 11 04 12-QM	☆	★	DNMG 333-QM	
			.411	.188	.047					
			15 1/2	14.7	4.76	0.79	DNMG 15 04 08-QM	☆	★	DNMG 432-QM
			.579	.188	.031					
14.3			4.76	1.19	DNMG 15 04 12-QM	☆	★	DNMG 433-QM		
.563			.188	.047						
15 1/2		15.1	6.35	0.40	DNMG 15 06 04-QM	☆	★	DNMG 441-QM		
		.595	.250	.016						
		14.7	6.35	0.79	DNMG 15 06 08-QM	☆	★	DNMG 442-QM		
		.579	.250	.031						
		14.3	6.35	1.19	DNMG 15 06 12-QM	☆	★	DNMG 443-QM		
		.563	.250	.047						
XM	15 1/2	14.7	6.35	1.59	DNMG 15 06 16-QM	☆	★	DNMG 444-QM		
		.547	.250	.063						
		14.7	6.35	0.79	DNMG 15 06 08-XM	☆	★	DNMG 442-XM		
		.579	.250	.031						
		14.3	6.35	1.19	DNMG 15 06 12-XM	☆	★	DNMG 443-XM		
		.563	.250	.047						

C

D

E

F



A26



F2

T-Max® P insert for turning

D-style insert (Rhombic 55°)

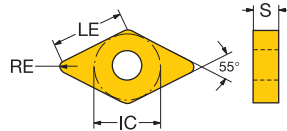
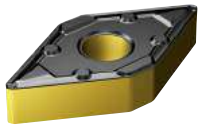

		LE	S	RE	ISO CODE	P		ANSI CODE						
						4415	4425							
Roughing	XMR	15	1/2	14.3	6.35	1.19	☆	★	DNMG 15 06 12-XMR	☆	★	DNMG 443-XMR		
				.563	.250	.047								
	PR	15	1/2	14.7	4.76	0.79	☆	★	DNMG 15 04 08-PR	☆	★	DNMG 432-PR		
						.579	.188	.031						
		15	1/2	14.3	4.76	1.19	☆	★	DNMG 15 04 12-PR	☆	★	DNMG 433-PR		
						.563	.188	.047						
		15	1/2	13.9	4.76	1.59	☆	★	DNMG 15 04 16-PR	☆	★	DNMG 434-PR		
						.547	.188	.063						
		15	1/2	14.7	6.35	0.79	☆	★	DNMG 15 06 08-PR	☆	★	DNMG 442-PR		
						.579	.250	.031						
		15	1/2	14.3	6.35	1.19	☆	★	DNMG 15 06 12-PR	☆	★	DNMG 443-PR		
						.563	.250	.047						
	15	1/2	13.9	6.35	1.59	☆	★	DNMG 15 06 16-PR	☆	★	DNMG 444-PR			
					.547	.250	.063							
	19	5/8	18.6	6.35	0.79	☆	★	DNMG 19 06 08-PR	☆	★	DNMG 542-PR			
					.731	.250	.031							
QR	15	1/2	14.7	6.35	0.79	☆	★	DNMM 15 06 08-PR	☆	★	DNMM 442-PR			
					.579	.250	.031							
	15	1/2	14.3	6.35	1.19	☆	★	DNMM 15 06 12-PR	☆	★	DNMM 443-PR			
					.563	.250	.047							
15	1/2	13.9	6.35	1.59	☆	★	DNMM 15 06 16-PR	☆	★	DNMM 444-PR				
				.547	.250	.063								
15	1/2	14.7	6.35	0.79	☆	★	DNMM 15 06 08-QR	☆	★	DNMM 442-QR				
				.579	.250	.031								
15	1/2	14.3	6.35	1.19	☆	★	DNMM 15 06 12-QR	☆	★	DNMM 443-QR				
				.563	.250	.047								

B

C

D

E

F



A26



F2

T-Max® P insert for turning

S-style insert (Square)

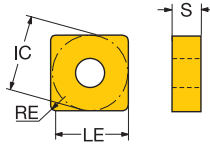
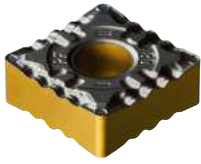

B

					ISO CODE	P		ANSI CODE					
		LE	S	RE		4415	4425						
Finishing	PF	12	1/2	11.9	4.76	0.79	★	★	SNMG 12 04 08-PF	★	★	SNMG 432-PF	
				.469	.188	.031							
		11.5	4.76	1.19			★	★	SNMG 12 04 12-PF	★	★	SNMG 433-PF	
		.453	.188	.047									
Medium	PM	09	3/8	9.1	3.18	0.40	★	★	SNMG 09 03 04-PM	★	★	SNMG 321-PM	
				.359	.125	.016							
		8.7	3.18	0.79			★	★	SNMG 09 03 08-PM	★	★	SNMG 322-PM	
				.344	.125	.031							
		12	1/2	12.3	4.76	0.40	★	★	SNMG 12 04 04-PM	★	★	SNMG 431-PM	
				.484	.188	.016							
			11.9	4.76	0.79	★	★	SNMG 12 04 08-PM	★	★	SNMG 432-PM		
			.469	.188	.031								
			11.5	4.76	1.19	★	★	SNMG 12 04 12-PM	★	★	SNMG 433-PM		
			.453	.188	.047								
			11.1	4.76	1.59	★	★	SNMG 12 04 16-PM	★	★	SNMG 434-PM		
			.437	.188	.063								
	QM	15	5/8	14.7	6.35	1.19	★	★	SNMG 15 06 12-PM	★	★	SNMG 543-PM	
			.578	.250	.047								
14.3		6.35	1.59			★	★	SNMG 15 06 16-PM	★	★	SNMG 544-PM		
		.562	.250	.063									
Roughing	PR	09	3/8	8.7	3.18	0.79	★	★	SNMG 09 03 08-QM	★	★	SNMG 322-QM	
				.344	.125	.031							
		12	1/2	11.9	4.76	0.79	★	★	SNMG 12 04 08-QM	★	★	SNMG 432-QM	
				.469	.188	.031							
		11.5	4.76	1.19			★	★	SNMG 12 04 12-QM	★	★	SNMG 433-QM	
				.453	.188	.047							
		PR	12	1/2	11.9	4.76	0.79	★	★	SNMG 12 04 08-PR	★	★	SNMG 432-PR
				.469	.188	.031							
	11.5		4.76	1.19			★	★	SNMG 12 04 12-PR	★	★	SNMG 433-PR	
				.453	.188	.047							
	11.1		4.76	1.59			★	★	SNMG 12 04 16-PR	★	★	SNMG 434-PR	
				.437	.188	.063							
	15		5/8	15.1	6.35	0.79	★	★	SNMG 15 06 08-PR	★	★	SNMG 542-PR	
				.594	.250	.031							
	14.7		6.35	1.19			★	★	SNMG 15 06 12-PR	★	★	SNMG 543-PR	
				.578	.250	.047							
	14.3		6.35	1.59			★	★	SNMG 15 06 16-PR	★	★	SNMG 544-PR	
				.562	.250	.063							
		PR	13.5	6.35	2.38			★	★	SNMG 15 06 24-PR	★	★	SNMG 546-PR
				.531	.250	.094							
	12		1/2	11.9	4.76	0.79	★	★	SNMM 12 04 08-PR	★	★	SNMM 432-PR	
				.469	.188	.031							
	11.5		4.76	1.19			★	★	SNMM 12 04 12-PR	★	★	SNMM 433-PR	
				.453	.188	.047							
15	5/8	14.7	6.35	1.19	★	★	SNMM 15 06 12-PR	★	★	SNMM 543-PR			
		.578	.250	.047									
14.3	6.35	1.59			★	★	SNMM 15 06 16-PR	★	★	SNMM 544-PR			
		.562	.250	.063									
	QR	19	3/4	17.9	6.35	1.19	★	★	SNMM 19 06 12-PR	★	★	SNMM 643-PR	
			.703	.250	.047								
17.5		6.35	1.59			★	★	SNMM 19 06 16-PR	★	★	SNMM 644-PR		
			.687	.250	.063								
16.7		6.35	2.38			★	★	SNMM 19 06 24-PR	★	★	SNMM 646-PR		
			.656	.250	.094								
19	3/4	17.9	6.35	1.19	★	★	SNMM 19 06 12-QR	★	★	SNMM 643-QR			
		.703	.250	.047									
17.5	6.35	1.59			★	★	SNMM 19 06 16-QR	★	★	SNMM 644-QR			
		.687	.250	.063									

F

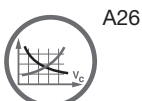

T-Max® P insert for turning

T-style insert (Triangular)

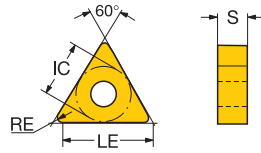
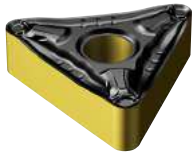

		LE	S	RE	ISO CODE	P		ANSI CODE		
						4415	4425			
Medium	PM	16	3/8	16.1	4.76	0.40	TNMG 16 04 04-PM	☆ ★	TNMG 331-PM	
				.634	.188	.016				
				15.7	4.76	0.79	TNMG 16 04 08-PM	☆ ★	TNMG 332-PM	
				.618	.188	.031				
				15.3	4.76	1.19	TNMG 16 04 12-PM	☆ ★	TNMG 333-PM	
		.602	.188	.047						
Roughing	PR	16	3/8	15.7	4.76	0.79	TNMG 16 04 08-PR	☆ ★	TNMG 332-PR	
				.618	.188	.031				
				15.3	4.76	1.19	TNMG 16 04 12-PR	☆ ★	TNMG 333-PR	
				.602	.188	.047				



A26



F2

T-Max® insert for turning

R-style insert (Round)

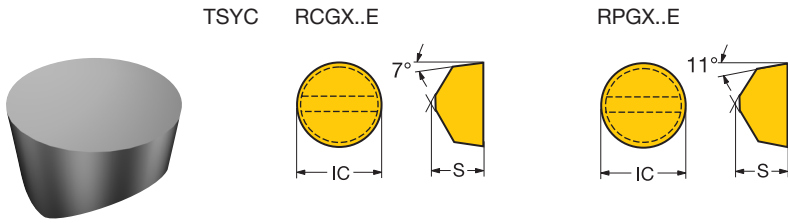

B
Metric version

					S	
					7014	
					*	
Medium	E		S	RE	ISO CODE	*
		06	6.35	3.18	RCGX060600E	*
			4.76	3.18	RPGX060400E	*
		09	7.94	4.76	RCGX090700E	*
		7.94	4.76	RPGX090700E	*	

C

D

E

F

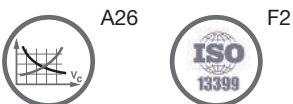

CoroTurn® XS solid carbide tool for turning

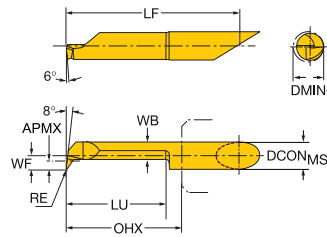

CZC _{MS}	DMIN ₁	LU	OHX	RE	APMX	Ordering code	Dimensions, mm			DCON _{MS}	WB	LF	WF	RMPX	
							P	M	N						
4	2.7	10.0	13.0	0.05	0.2	CXS-04T098-05-2710R	☆	★	☆	★	4	2.1	27.3	1.2	17°
4	2.7	10.0	13.0	0.15	0.2	CXS-04T098-15-2710R	☆	★	☆	★	4	2.1	27.3	1.2	17°
4	2.7	15.0	18.0	0.15	0.2	CXS-04T098-15-2715R	☆	★	☆	★	4	2.1	32.3	1.2	17°
4	3.2	15.0	18.0	0.05	0.2	CXS-04T098-05-3215R	☆	★	☆	★	4	2.6	32.3	1.5	17°
4	3.2	10.0	13.0	0.15	0.2	CXS-04T098-15-3210R	☆	★	☆	★	4	2.6	27.3	1.5	17°
4	3.2	15.0	18.0	0.15	0.2	CXS-04T098-15-3215R	☆	★	☆	★	4	2.6	32.3	1.5	17°
4	3.2	20.0	23.0	0.15	0.2	CXS-04T098-15-3220R	☆	★	☆	★	4	2.6	37.3	1.5	17°
4	4.2	15.0	18.0	0.05	0.3	CXS-04T098-05-4215R	☆	★	☆	★	4	3.5	32.3	2.0	17°
4	4.2	10.0	13.0	0.15	0.3	CXS-04T098-15-4210R	☆	★	☆	★	4	3.5	27.3	2.0	17°
4	4.2	15.0	18.0	0.15	0.3	CXS-04T098-15-4215R	☆	★	☆	★	4	3.5	32.3	2.0	17°
4	4.2	20.0	23.0	0.15	0.3	CXS-04T098-15-4220R	☆	★	☆	★	4	3.5	37.3	2.0	17°
4	4.2	25.0	28.0	0.15	0.3	CXS-04T098-15-4225R	☆	★	☆	★	4	3.5	42.3	2.0	17°
5	5.2	20.0	23.0	0.05	0.5	CXS-05T098-05-5220R	☆	★	☆	★	5	4.3	42.3	2.5	17°
5	5.2	10.0	13.0	0.20	0.5	CXS-05T098-20-5210R	☆	★	☆	★	5	4.3	32.3	2.5	17°
5	5.2	20.0	23.0	0.20	0.5	CXS-05T098-20-5220R	☆	★	☆	★	5	4.3	42.3	2.5	17°
5	5.2	25.0	28.0	0.20	0.5	CXS-05T098-20-5225R	☆	★	☆	★	5	4.3	47.3	2.5	17°
5	5.2	30.0	33.0	0.20	0.5	CXS-05T098-20-5230R	☆	★	☆	★	5	4.3	52.3	2.5	17°
6	6.2	15.0	18.0	0.20	0.5	CXS-06T098-20-6215R	☆	★	☆	★	6	5.3	37.3	3.0	17°
6	6.2	20.0	23.0	0.20	0.5	CXS-06T098-20-6220R	☆	★	☆	★	6	5.3	42.3	3.0	17°
6	6.2	25.0	28.0	0.20	0.5	CXS-06T098-20-6225R	☆	★	☆	★	6	5.3	47.3	3.0	17°
6	6.2	30.0	33.0	0.20	0.5	CXS-06T098-20-6230R	☆	★	☆	★	6	5.3	52.3	3.0	17°
6	6.2	40.0	43.0	0.20	0.5	CXS-06T098-20-6240R	☆	★	☆	★	6	5.3	62.3	3.0	17°
7	7.2	25.0	28.0	0.20	0.5	CXS-07T098-20-7225R	☆	★	☆	★	7	6.3	47.3	3.5	17°
7	7.2	30.0	33.0	0.20	0.5	CXS-07T098-20-7230R	☆	★	☆	★	7	6.3	52.3	3.5	17°
7	7.2	50.0	53.0	0.20	0.5	CXS-07T098-20-7250R	☆	★	☆	★	7	6.3	72.3	3.5	17°

CZC_{MS} to correspond with CZC_{WS} on adaptor.

R = Right hand, L = Left hand



F2

Cutting speed recommendations

The recommendations are valid for use with cutting fluid.

ISO P	CMC No.	Steel	Specific cutting force k_{c1}	Hardness Brinell	<<<< WEAR RESISTANCE		
					GC4415	GC4425	
					h_{ex} mm = feed f_n mm/r		
					Cutting speed (v_c), m/min		
MC No.	Material	N/mm ²	HB				
P1.1.Z.AN	01.1	Unalloyed steel C = 0.1–0.25%	1500	125	560-400-290	500-340-240	
P1.2.Z.AN	01.2	C = 0.25–0.55%	1600	190	565-345-230	550-300-185	
P1.3.Z.AN	01.3	C = 0.55–0.80%	1700	190	455-325-240	395-265-190	
P2.1.Z.AN	02.1	Low-alloy steel (alloying elements ≤5%) Non-hardened	1700	175	440-315-240	430-305-230	
P2.5.Z.HT	02.2	Hardened and tempered	1850	330	310-200-145	275-180-135	
P3.0.Z.AN	03.11	High-alloy steel (alloying elements >5%) Annealed	1950	200	410-270-200	300-205-150	
P3.0.Z.HT	03.21	Hardened tool steel	3000	380	170-110-80	115-80-65	
P1.5.C.UT	06.1	Steel castings Unalloyed	1550	150	410-295-230	365-270-195	
P2.6.C.UT	06.2	Low-alloy (alloying elements ≤5%)	1600	200	265-185-145	250-170-120	
P3.0.C.UT	06.3	High-alloy (alloying elements >5%)	2050	200	235-160-120	215-145-105	
ISO M	CMC No.	Stainless steel	Specific cutting force k_{c1}	Hardness Brinell	<<<< WEAR RESISTANCE		
					GC1105	GC2220	
					h_{ex} mm = feed f_n mm/r		
					Cutting speed (v_c), m/min		
MC No.	Material	N/mm ²	HB				
M1.0.Z.AQ	05.21	Austenitic Bars/forged Austenitic	1800	200	215-140-105	225-165-125	
M1.0.Z.PH	05.22	PH-hardened	2850	300	245-160-110	100-70-55	
M2.0.Z.AQ	05.23	Super austenitic	2250	200	250-165-115	130-100-75	
M3.1.Z.AQ	05.51	Austenitic-ferritic (Duplex) Bars/forged Non-weldable ≥ 0.05%C	2000	230	315-205-145	190-150-110	
M3.2.Z.AQ	05.52	Weldable < 0.05%C	2450	260	280-185-130	150-120-90	
M1.0.C.UT	15.21	Austenitic Cast Austenitic	1700	200	-	200-155-115	
M2.0.C.AQ	15.23	Super austenitic	2150	200	-	130-90-65	
M3.1.C.AQ	15.51	Austenitic-ferritic (Duplex) Cast Non-weldable ≥ 0.05%C	1800	230	-	150-120-90	
M3.2.C.AQ	15.52	Weldable < 0.05%C	2250	260	-	125-105-80	
ISO S	CMC No.	Heat resistant material	Specific cutting force k_{c1}	Hardness Brinell	<<<< WEAR RESISTANCE		
					GC1105	CB7014	
					h_{ex} mm = feed f_n mm/r		
					Cutting speed (v_c), m/min		
MC No.	Material	N/mm ²	HB				
S1.0.U.AN	20.11	Heat resistant super alloys Iron base Annealed or solution treated	2400	200	150-100-70	-	
S1.0.U.AG	20.12	Aged or solution treated and aged	2500	280	120-80-60	-	
S2.0.Z.AN	20.21	Nickel base Annealed or solution treated	2650	250	90-55-30	320-280-250	
S2.0.Z.AG	20.22	Aged or solution treated and aged	2900	350	80-50-27	280-245-220	
S2.0.C.NS	20.24	Cast or cast and aged	3000	320	70-45-24	200-155-130	
S3.0.Z.AN	20.31	Cobalt alloys Annealed or solution treated	2700	200	90-60-30	250-190-160	
S3.0.Z.AG	20.32	Solution treated and aged	3000	300	80-50-27	250-190-160	
S3.0.C.NS	20.33	Cast or cast and aged	3100	320	70-45-24	200-155-130	

Milling

High-feed milling tools

CoroMill® 415

B2

Disc milling tools

CoroMill® 331 adjustable half side and face disc milling cutter
CoroMill® 331 adjustable half side and back face disc milling cutter

B3-B6

B7-B11

Optimized solid milling tools

CoroMill® Plura solid carbide end mill for plunging
CoroMill® Plura solid carbide end mill for high feed side milling
CoroMill® Plura solid carbide end mill for stable multi-operations milling

B12-B13

B14-B15

B16-B18

Cutting data

B19-B21

For complete assortment, see www.sandvik.coromant.com

CoroMill® 415 insert for milling

ENG

B

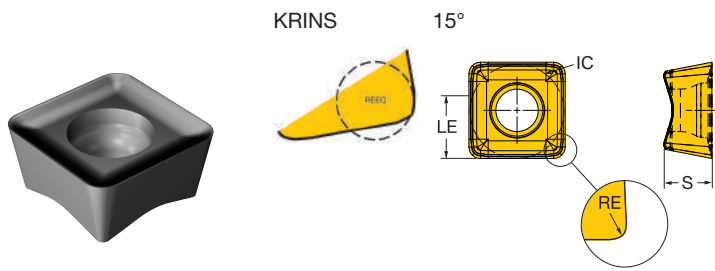

C

				P	M	S	Dimensions, mm							
		RE	Ordering code	T040	T040	S00T	S00T	S00T	IC	LE	S	BS	BSR	REEQ
M30	05	1.20	415N-05 02 12E-M30	☆	★	☆	☆	★	5.0	3.0	2.21	0.0	1.2	2.00
	07	2.00	415N-07 03 20E-M30	☆	★	☆	☆	★	7.0	3.0	3.07	0.0	1.2	2.80

D

E

F



F2



CoroMill® 331 adjustable half side and face disc milling cutter

Bore with keyway - Internal coolant supply





KAPR 90°

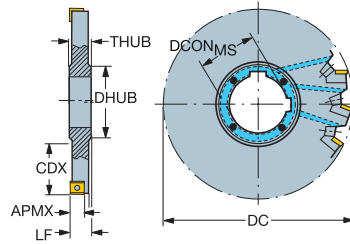

N331.1A



Metric version

							Dimensions, mm											
DC	CDX		CZC _{MS}	APMX	CNSC		Ordering code	DCON _{MS}	LF	DRVCT	DHUB	THUB				RPMX	CICT	MIID
80	19.5	08	27	7.6	1	6	R331.52C-080S27EM	27.0	13.00	1	39.0	16.0	80	1.4	0.23	18100	6	N331.1A-08
100	25.5	08	32	7.6	1	8	R331.52C-100S32EM	32.0	13.00	1	47.0	16.0	80	1.4	0.37	15900	8	N331.1A-08
125	34.0	08	40	7.6	1	10	R331.52C-125S40EM	40.0	13.00	2	55.0	16.0	80	1.4	0.60	14100	10	N331.1A-08
160	51.5	08	40	7.6	1	12	R331.52C-160S40EM	40.0	13.00	1	55.0	16.0	80	1.4	1.10	12400	12	N331.1A-08
80	19.5	08	27	7.6	1	6	R331.52C-080S27FM	27.0	14.00	1	39.0	16.0	80	1.4	0.27	18100	6	N331.1A-08
100	25.5	08	32	7.6	1	8	R331.52C-100S32FM	32.0	14.00	1	47.0	16.0	80	1.4	0.44	15900	8	N331.1A-08
125	34.0	08	40	7.6	1	10	R331.52C-125S40FM	40.0	14.00	2	55.0	16.0	80	1.4	0.72	14100	10	N331.1A-08
160	51.5	08	40	7.6	1	12	R331.52C-160S40FM	40.0	14.00	1	55.0	16.0	80	1.4	1.33	12400	12	N331.1A-08
100	25.5	11	32	10.6	1	6	R331.52C-100S32KM	32.0	16.75	2	47.0	18.5	80	3.0	0.54	14000	6	N331.1A-11
125	34.0	11	40	10.6	1	8	R331.52C-125S40KM	40.0	16.75	1	55.0	18.5	80	3.0	0.88	12400	8	N331.1A-11
160	51.5	11	40	10.6	1	10	R331.52C-160S40KM	40.0	16.75	2	55.0	18.5	80	3.0	1.62	10800	10	N331.1A-11

Spare parts			
Ordering code	Insert screw	Wedge	Screw
R331.52C-125S40EM	5513 020-24	5431 105-01	339-831
R331.52C-125S40FM	5513 020-24	5431 105-02	339-831
R331.52C-080S27EM	5513 020-24	5431 105-01	339-831
R331.52C-080S27FM	5513 020-24	5431 105-02	339-831
R331.52C-100S32EM	5513 020-24	5431 105-01	339-831
R331.52C-100S32FM	5513 020-24	5431 105-02	339-831
R331.52C-160S40EM	5513 020-24	5431 105-01	339-831
R331.52C-160S40FM	5513 020-24	5431 105-02	339-831
R331.52C-100S32KM	5513 020-29	5431 105-04	5516 010-02
R331.52C-160S40KM	5513 020-29	5431 105-04	339-831
R331.52C-125S40KM	5513 020-29	5431 105-04	339-831

For complete list of spare parts, see www.sandvik.coromant.com



F2



F5

CoroMill® 331 adjustable half side and face disc milling cutter

Bore with keyway - Internal coolant supply

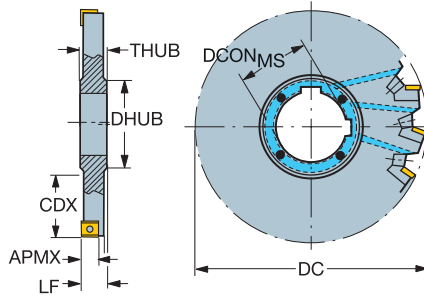

KAPR 90°



N331.1A

B

Inch version

										Dimensions, inch											
DC	CDX		CZX _{MS}	APMX	CNSC		Ordering code	DCON _{MS}	LF	DRVCT	DHUB	THUB	PSI	FT/LBS	LBS	RPMX	CICT	MIID			
3.150	.768	08	1	.299	1	6	R331.52C-080T25FM	1.000	.551	1	1.535	.630	1160	1.0	0.56	18100	6	N331.1A-08			
4.000	1.043	08	1 1/4	.299	1	8	R331.52C-101T32FM	1.250	.551	1	1.811	.630	1160	1.0	0.94	15900	8	N331.1A-08			
5.000	1.437	08	1 1/2	.299	1	10	R331.52C-127T38FM	1.500	.551	2	2.047	.630	1160	1.0	1.59	14100	10	N331.1A-08			
6.000	1.929	08	1 1/2	.299	1	12	R331.52C-152T38FM	1.500	.551	1	2.047	.728	1160	1.0	2.51	12400	12	N331.1A-08			
5.000	1.437	11	1 1/2	.417	1	8	R331.52C-127T38KM	1.500	.659	1	2.047	.728	1160	2.2	2.03	12400	8	N331.1A-11			
6.000	1.929	11	1 1/2	.417	1	10	R331.52C-152T38KM	1.500	.659	2	2.047	.728	1160	2.2	3.15	10800	10	N331.1A-11			

Spare parts			
Ordering code	Insert screw	Wedge	Screw
R331.52C-080T25FM	5513 020-24	5431 105-02	339-831
R331.52C-101T32FM	5513 020-24	5431 105-02	339-831
R331.52C-127T38FM	5513 020-24	5431 105-02	339-831
R331.52C-152T38FM	5513 020-24	5431 105-02	339-831
R331.52C-152T38KM	5513 020-29	5431 105-04	339-831
R331.52C-127T38KM	5513 020-29	5431 105-04	339-831

For complete list of spare parts, see www.sandvik.coromant.com

E

F



CoroMill® 331 adjustable half side and face disc milling cutter

Arbor - Internal coolant supply

STDNO ISO6462
KAPR 90°

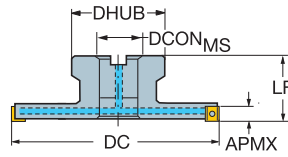

N331.1A

Metric version

						Dimensions, mm											
DC	CZC _{MS}	APMX	CNSC		Ordering code	DCON _{MS}	ISO	LF	DHUB	BAR	NM	KG	RPMX	CICT	MIID		
80	08	27	7.6	1	6	R331.52C-080Q27EMR	27.0	A	50.00	51.0	80	1.4	0.56	18100	6	N331.1A-08	
100	08	27	7.6	1	8	R331.52C-100Q27EMR	27.0	A	50.00	51.0	80	1.4	0.87	15900	8	N331.1A-08	
125	08	32	7.6	1	10	R331.52C-125Q32EMR	32.0	B	50.00	61.0	80	1.4	1.10	14100	10	N331.1A-08	
160	08	40	7.6	1	12	R331.52C-160Q40EMR	40.0	B	50.00	73.0	80	1.4	1.73	12400	12	N331.1A-08	
80	08	27	7.6	1	6	R331.52C-080Q27FMR	27.0	A	50.00	51.0	80	1.4	0.59	18100	6	N331.1A-08	
100	08	27	7.6	1	8	R331.52C-100Q27FMR	27.0	A	50.00	51.0	80	1.4	0.93	15900	8	N331.1A-08	
125	08	32	7.6	1	10	R331.52C-125Q32FMR	32.0	B	50.00	61.0	80	1.4	1.21	14100	10	N331.1A-08	
160	08	40	7.6	1	12	R331.52C-160Q40FMR	40.0	B	50.00	73.0	80	1.4	1.93	12400	12	N331.1A-08	
100	11	27	10.6	1	6	R331.52C-100Q27KMR	27.0	A	50.00	51.0	80	3.0	0.95	14000	6	N331.1A-11	
125	11	32	10.6	1	8	R331.52C-125Q32KMR	32.0	B	50.00	61.0	80	3.0	1.33	12400	8	N331.1A-11	
160	11	40	10.6	1	10	R331.52C-160Q40KMR	40.0	B	50.00	73.0	80	3.0	2.17	10800	10	N331.1A-11	

Spare parts			
Ordering code	Insert screw	Wedge	Screw
R331.52C-080Q27EMR	5513 020-24	5431 105-01	339-831
R331.52C-080Q27FMR	5513 020-24	5431 105-02	269-832
R331.52C-100Q27EMR	5513 020-24	5431 105-01	339-831
R331.52C-100Q27FMR	5513 020-24	5431 105-02	339-831
R331.52C-125Q32EMR	5513 020-24	5431 105-01	339-831
R331.52C-125Q32FMR	5513 020-24	5431 105-02	339-831
R331.52C-160Q40EMR	5513 020-24	5431 105-01	339-831
R331.52C-160Q40FMR	5513 020-24	5431 105-02	339-831
R331.52C-100Q27KMR	5513 020-29	5431 105-04	339-831
R331.52C-125Q32KMR	5513 020-29	5431 105-04	339-831
R331.52C-160Q40KMR	5513 020-29	5431 105-04	339-831

For complete list of spare parts, see www.sandvik.coromant.com



F2



F5

CoroMill® 331 adjustable half side and face disc milling cutter

Cylindrical shank - Internal coolant supply

KAPR 90°



N331.1A

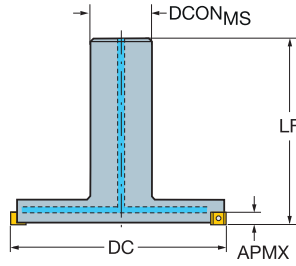

B

Metric version

						Dimensions, mm								
DC	CZC _{MS}	APMX	CNSC	Ordering code	DCON _{MS}	LF	BAR	NM	KG	RPMX	CICT	MIID		
80	08	32	7.6	1	6	R331.52C-080A32EMR	32.0	115.00	80	1.4	0.87	15900	6	N331.1A-08
100	08	40	7.6	1	8	R331.52C-100A40EMR	40.0	125.00	80	1.4	1.64	15900	8	N331.1A-08

Spare parts			
Ordering code	Insert screw	Wedge	Screw
R331.52C-080A32EMR	5513 020-24	5431 105-01	339-831
R331.52C-100A40EMR	5513 020-24	5431 105-01	339-831

For complete list of spare parts, see www.sandvik.coromant.com

D

E

F



F2



F5

CoroMill® 331 adjustable half side and back face disc milling cutter



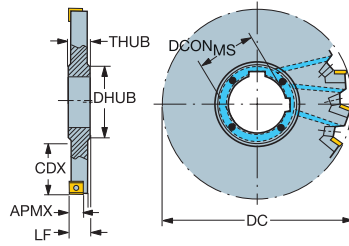

Bore with keyway - Internal coolant supply

KAPR 90°



N331.1A

Metric version

							Dimensions, mm											
DC	CDX		CZC _{MS}	APMX	CNSC		Ordering code	DCON _{MS}	LF	DRVCT	DHUB	THUB				RPMX	CICT	MIID
80	19.5	08	27	7.6	1	6	L331.52C-080S27EM	27.0	13.00	1	39.0	16.0	80	1.4	0.23	18100	6	N331.1A-08
100	25.5	08	32	7.6	1	8	L331.52C-100S32EM	32.0	13.00	1	47.0	16.0	80	1.4	0.37	15900	8	N331.1A-08
125	34.0	08	40	7.6	1	10	L331.52C-125S40EM	40.0	13.00	2	55.0	16.0	80	1.4	0.60	14100	10	N331.1A-08
160	51.5	08	40	7.6	1	12	L331.52C-160S40EM	40.0	13.00	1	55.0	16.0	80	1.4	1.10	12400	12	N331.1A-08
80	19.5	08	27	7.6	1	6	L331.52C-080S27FM	27.0	14.00	1	39.0	16.0	80	1.4	0.27	18100	6	N331.1A-08
100	25.5	08	32	7.6	1	8	L331.52C-100S32FM	32.0	14.00	1	47.0	16.0	80	1.4	0.44	15900	8	N331.1A-08
125	34.0	08	40	7.6	1	10	L331.52C-125S40FM	40.0	14.00	2	55.0	16.0	80	1.4	0.72	14100	10	N331.1A-08
160	51.5	08	40	7.6	1	12	L331.52C-160S40FM	40.0	14.00	1	55.0	16.0	80	1.4	1.33	12400	12	N331.1A-08
100	25.5	11	32	10.6	1	6	L331.52C-100S32KM	32.0	16.75	2	47.0	18.5	80	3.0	0.54	14000	6	N331.1A-11
125	34.0	11	40	10.6	1	8	L331.52C-125S40KM	40.0	16.75	1	55.0	18.5	80	3.0	0.88	12400	8	N331.1A-11
160	51.5	11	40	10.6	1	10	L331.52C-160S40KM	40.0	16.75	2	55.0	18.5	80	3.0	1.62	10800	10	N331.1A-11

Spare parts			
Ordering code	Insert screw	Wedge	Screw
L331.52C-125S40EM	5513 020-24	5431 105-01	339-831
L331.52C-125S40FM	5513 020-24	5431 105-02	339-831
L331.52C-080S27EM	5513 020-24	5431 105-01	339-831
L331.52C-080S27FM	5513 020-24	5431 105-02	339-831
L331.52C-100S32EM	5513 020-24	5431 105-01	339-831
L331.52C-100S32FM	5513 020-24	5431 105-02	339-831
L331.52C-160S40EM	5513 020-24	5431 105-01	339-831
L331.52C-160S40FM	5513 020-24	5431 105-02	339-831
L331.52C-100S32KM	5513 020-29	5431 105-04	5516 010-02
L331.52C-160S40KM	5513 020-29	5431 105-04	339-831
L331.52C-125S40KM	5513 020-29	5431 105-04	339-831

For complete list of spare parts, see www.sandvik.coromant.com



F2



F5

CoroMill® 331 adjustable half side and back face disc milling cutter

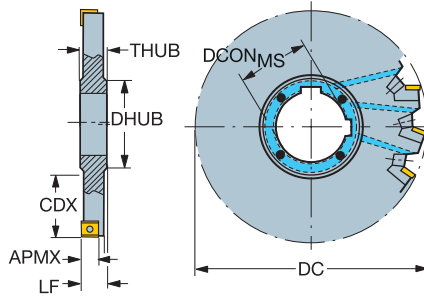

Bore with keyway - Internal coolant supply

KAPR 90°



N331.1A

Inch version

								Dimensions, inch											
DC	CDX		CZC _{MS}	APMX	CNSC		Ordering code	DCON _{MS}	LF	DRVCT	DHUB	THUB	PSI	FT/LBS	LBS	RPMX	CICT	MIID	
3.150	.768	08	1	.299	1	6	L331.52C-080T25FM	1.000	.551	1	1.535	.630	1160	1.0	0.56	18100	6	N331.1A-08	
4.000	1.043	08	1 1/4	.299	1	8	L331.52C-101T32FM	1.250	.551	1	1.811	.630	1160	1.0	0.94	15900	8	N331.1A-08	
5.000	1.437	08	1 1/2	.299	1	10	L331.52C-127T38FM	1.500	.551	2	2.047	.630	1160	1.0	1.59	14100	10	N331.1A-08	
6.000	1.929	08	1 1/2	.299	1	12	L331.52C-152T38FM	1.500	.551	1	2.047	.728	1160	1.0	2.51	12400	12	N331.1A-08	
5.000	1.437	11	1 1/2	.417	1	8	L331.52C-127T38KM	1.500	.659	1	2.047	.728	1160	2.2	2.03	12400	8	N331.1A-11	
6.000	1.929	11	1 1/2	.417	1	10	L331.52C-152T38KM	1.500	.659	2	2.047	.728	1160	2.2	3.15	10800	10	N331.1A-11	

Spare parts			
Ordering code	Insert screw	Wedge	Screw
L331.52C-080T25FM	5513 020-24	5431 105-02	339-831
L331.52C-101T32FM	5513 020-24	5431 105-02	339-831
L331.52C-127T38FM	5513 020-24	5431 105-02	339-831
L331.52C-152T38FM	5513 020-24	5431 105-02	339-831
L331.52C-152T38KM	5513 020-29	5431 105-04	339-831
L331.52C-127T38KM	5513 020-29	5431 105-04	339-831

For complete list of spare parts, see www.sandvik.coromant.com



CoroMill® 331 adjustable half side and back face disc milling cutter



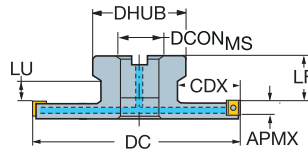

Arbor - Internal coolant supply

STDNO ISO6462
KAPR 90°



N331.1A

Metric version

DC	CDX		CZC _{MS}	APMX	CNSC		Ordering code	DCON _{MS}	ISO	LF	DHUB				RPMX	CICT	MIID
80	20.3	08	27	7.6	1	6	R331.52C-080Q27EML	27.0	A	40.00	51.0	80	1.4	0.56	18100	6	N331.1A-08
100	23.5	08	27	7.6	1	8	R331.52C-100Q27EML	27.0	A	40.00	51.0	80	1.4	0.87	15900	8	N331.1A-08
125	31.0	08	32	7.6	1	10	R331.52C-125Q32EML	32.0	B	40.00	61.0	80	1.4	1.10	14100	10	N331.1A-08
160	42.5	08	40	7.6	1	12	R331.52C-160Q40EML	40.0	B	40.00	73.0	80	1.4	1.73	12400	12	N331.1A-08
80	20.3	08	27	7.6	1	6	R331.52C-080Q27FML	27.0	A	38.00	51.0	80	1.4	0.59	18100	6	N331.1A-08
100	23.5	08	27	7.6	1	8	R331.52C-100Q27FML	27.0	A	38.00	51.0	80	1.4	0.93	15900	8	N331.1A-08
125	31.0	08	32	7.6	1	10	R331.52C-125Q32FML	32.0	B	38.00	61.0	80	1.4	1.21	14100	10	N331.1A-08
160	42.5	08	40	7.6	1	12	R331.52C-160Q40FML	40.0	B	38.00	73.0	80	1.4	1.94	12400	12	N331.1A-08
100	25.8	11	27	10.6	1	6	R331.52C-100Q27KML	27.0	A	35.00	51.0	80	3.0	0.96	14000	6	N331.1A-11
125	31.0	11	32	10.6	1	8	R331.52C-125Q32KML	32.0	B	35.00	61.0	80	3.0	1.33	12400	8	N331.1A-11
160	42.5	11	40	10.6	1	10	R331.52C-160Q40KML	40.0	B	35.00	73.0	80	3.0	2.17	10800	10	N331.1A-11

Ordering code	Spare parts		
	Insert screw	Wedge	Screw
R331.52C-080Q27EML	5513 020-24	5431 105-01	339-831
R331.52C-080Q27FML	5513 020-24	5431 105-02	269-832
R331.52C-100Q27EML	5513 020-24	5431 105-01	339-831
R331.52C-100Q27FML	5513 020-24	5431 105-02	339-831
R331.52C-125Q32EML	5513 020-24	5431 105-01	339-831
R331.52C-125Q32FML	5513 020-24	5431 105-02	339-831
R331.52C-160Q40EML	5513 020-24	5431 105-01	339-831
R331.52C-160Q40FML	5513 020-24	5431 105-02	339-831
R331.52C-100Q27KML	5513 020-29	5431 105-04	339-831
R331.52C-125Q32KML	5513 020-29	5431 105-04	339-831
R331.52C-160Q40KML	5513 020-29	5431 105-04	339-831

For complete list of spare parts, see www.sandvik.coromant.com



F2



F5

CoroMill® 331 adjustable half side and back face disc milling cutter

Arbor - Internal coolant supply

STDNO ISO6462
KAPR 90°

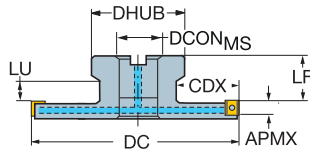

B



N331.1A

Inch version

C

							Dimensions, inch											
DC	CDX		CZC _{MS}	APMX	CNSC		Ordering code	DCON _{MS}	ISO	LF	DHUB	PSI	FT/LBS	LBS	RPMX	CICT	MIID	
3.150	.799	08	1	.299	1	6	R331.52C-080R25FML	1.000	A	1.528	2.008	1160	1.0	1.31	18100	6	N331.1A-08	
4.000	.957	08	1	.299	1	8	R331.52C-101R25FML	1.000	A	1.528	2.008	1160	1.0	2.10	15900	8	N331.1A-08	
5.000	1.260	08	1 1/4	.299	1	10	R331.52C-127R32FML	1.250	B	1.528	2.402	1160	1.0	2.65	14100	10	N331.1A-08	
4.000	1.016	11	1	.417	1	6	R331.52C-101R25KML	1.000	A	1.409	2.008	1160	2.2	2.26	14000	6	N331.1A-11	

D

Spare parts			
Ordering code	Insert screw	Wedge	Screw
R331.52C-080R25FML	5513 020-24	5431 105-02	269-832
R331.52C-101R25FML	5513 020-24	5431 105-02	339-831
R331.52C-127R32FML	5513 020-24	5431 105-02	339-831
R331.52C-101R25KML	5513 020-29	5431 105-04	339-831

For complete list of spare parts, see www.sandvik.coromant.com

E

F



CoroMill® 331 adjustable half side and back face disc milling cutter

Cylindrical shank - Internal coolant supply





KAPR 90°

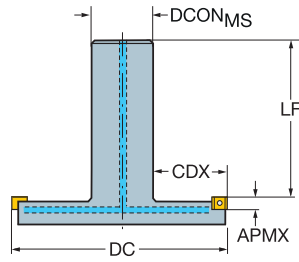

N331.1A



Metric version

							Dimensions, mm								
DC	CDX		CZC _{MS}	APMX	CNSC		Ordering code	DCON _{MS}	LF				RPMX	CICT	MIID
80	23.0	08	32	7.6	1	6	R331.52C-080A32EML	32.0	105.00	80	1.4	0.87	18100	6	N331.1A-08
100	29.0	08	40	7.6	1	8	R331.52C-100A40EML	40.0	115.00	80	1.4	1.49	15900	8	N331.1A-08

Spare parts			
Ordering code	Insert screw	Wedge	Screw
R331.52C-080A32EML	5513 020-24	5431 105-01	339-831
R331.52C-100A40EML	5513 020-24	5431 105-01	339-831

For complete list of spare parts, see www.sandvik.coromant.com



F2



F5

CoroMill® Plura solid carbide end mill for plunging

For nickel-based alloys

FHA 0°
TCDCON h5

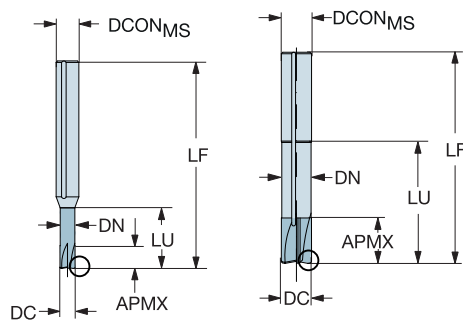
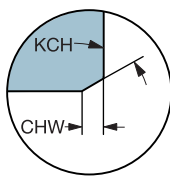
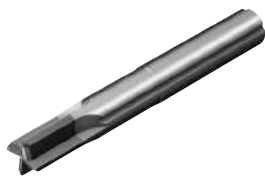

B

Metric version

										s	Dimensions, mm		
DC	CZC _{MS}	APMX	CHW	KCH	LU	CNSC	CXSC	ZEFP	Ordering code	1610	DCON _{MS}	LF	DN
4.0	6	1.3	0.48	10°	16.0	4	4	4	2P070-0400-PB	★	6.0	54.9	3.9
6.0	6	2.0	0.72	10°	24.0	4	4	4	2P070-0600-PB	★	6.0	60.3	5.8
8.0	8	2.6	0.96	10°	32.0	4	4	4	2P070-0800-PB	★	8.0	68.4	7.8
10.0	10	3.3	1.20	10°	40.0	4	4	4	2P070-1000-PB	★	10.0	80.4	9.7
12.0	12	4.0	1.44	10°	48.0	4	4	4	2P070-1200-PB	★	12.0	92.5	11.6
16.0	16	5.3	1.92	10°	64.0	4	4	4	2P070-1600-PB	★	16.0	111.7	15.5

C

Inch version

										s	Dimensions, inch		
DC	CZC _{MS}	APMX	CHW	KCH	LU	CNSC	CXSC	ZEFP	Ordering code	1610	DCON _{MS}	LF	DN
.187	1/4	.062	.022	10°	.748	4	4	4	2P070-0476-PB	★	.250	2.264	.182
.250	1/4	.083	.030	10°	1.000	4	4	4	2P070-0635-PB	★	.250	2.429	.243
.375	3/8	.124	.045	10°	1.500	4	4	4	2P070-0953-PB	★	.375	3.091	.364
.500	1/2	.165	.060	10°	2.000	4	4	4	2P070-1270-PB	★	.500	3.756	.485
.625	5/8	.206	.075	10°	2.500	4	4	4	2P070-1588-PB	★	.625	4.378	.606



CoroMill® Plura solid carbide end mill for plunging

For nickel-based alloys

FHA 0°
TCDCON h5

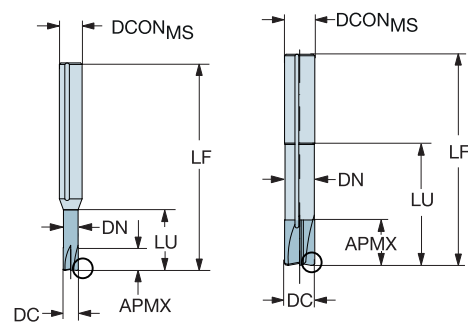
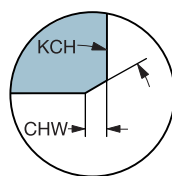

Metric version

										s	Dimensions, mm		
DC	CZC _{MS}	APMX	CHW	KCH	LU	CNSC	CXSC	ZEFP	Ordering code	1610	DCON _{MS}	LF	DN
4.0	6	1.3	0.48	10°	24.0	4	4	4	2P090-0400-PB	★	6.0	62.9	3.9
6.0	6	2.0	0.72	10°	36.0	4	4	4	2P090-0600-PB	★	6.0	72.3	5.8
8.0	8	2.6	0.96	10°	48.0	4	4	4	2P090-0800-PB	★	8.0	84.4	7.8
10.0	10	3.3	1.20	10°	60.0	4	4	4	2P090-1000-PB	★	10.0	100.4	9.7
12.0	12	4.0	1.44	10°	72.0	4	4	4	2P090-1200-PB	★	12.0	116.5	11.6
16.0	16	5.3	1.92	10°	96.0	4	4	4	2P090-1600-PB	★	16.0	143.7	15.5



B19



F2



F5



F6

CoroMill® Plura solid carbide end mill for high feed side milling

For titanium alloys

FHA 45°
 BSG COROMANT
 TCDC h10
 TCDCON h6

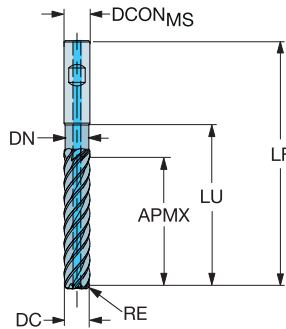

Metric version

C

									s	Dimensions, mm		
DC	CZC _{MS}	APMX	RE	LU	CNSC	CXSC	ZEFP	Ordering code	1745	DCON _{MS}	LF	DN
6.0	6	30.0	0.50	34.0	1	1	5	2F380-0600-050ASD	★	6.0	72.0	5.7
	6	30.0	1.00	34.0	1	1	5	2F380-0600-100ASD	★	6.0	72.0	5.7
8.0	8	40.0	0.50	45.0	1	1	5	2F380-0800-050ASD	★	8.0	82.0	7.6
	8	40.0	1.00	45.0	1	1	5	2F380-0800-100ASD	★	8.0	82.0	7.6
10.0	10	50.0	0.50	56.0	1	1	5	2F380-1000-050ASD	★	10.0	97.0	9.5
	10	50.0	1.00	56.0	1	1	5	2F380-1000-100ASD	★	10.0	97.0	9.5
	10	50.0	2.00	56.0	1	1	5	2F380-1000-200ASD	★	10.0	97.0	9.5
12.0	12	60.0	1.00	67.0	1	1	5	2F380-1200-100ASD	★	12.0	115.0	11.4
	12	60.0	2.00	67.0	1	1	5	2F380-1200-200ASD	★	12.0	115.0	11.4
	12	60.0	2.50	67.0	1	1	5	2F380-1200-250ASD	★	12.0	115.0	11.4
	12	60.0	3.00	67.0	1	1	5	2F380-1200-300ASD	★	12.0	115.0	11.4
16.0	16	80.0	2.00	89.0	1	1	5	2F380-1600-200ASD	★	16.0	140.0	15.2
	16	80.0	2.50	89.0	1	1	5	2F380-1600-250ASD	★	16.0	140.0	15.2
	16	80.0	3.00	89.0	1	1	5	2F380-1600-300ASD	★	16.0	140.0	15.2
	16	80.0	4.00	89.0	1	1	5	2F380-1600-400ASD	★	16.0	140.0	15.2
20.0	20	100.0	3.00	111.0	1	1	5	2F380-2000-300ASD	★	20.0	165.0	19.0
	20	100.0	4.00	111.0	1	1	5	2F380-2000-400ASD	★	20.0	165.0	19.0
	20	100.0	6.35	111.0	1	1	5	2F380-2000-635ASD	★	20.0	165.0	19.0
25.0	25	125.0	3.00	138.5	1	1	5	2F380-2500-300ASD	★	25.0	203.0	23.8
	25	125.0	4.00	138.5	1	1	5	2F380-2500-400ASD	★	25.0	203.0	23.8
	25	125.0	6.35	138.5	1	1	5	2F380-2500-635ASD	★	25.0	203.0	23.8

E

F



CoroMill® Plura solid carbide end mill for high feed side milling

For titanium alloys

FHA 45°
 BSG COROMANT
 TCDC h10
 TCDCON h6

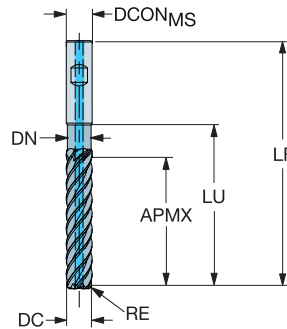

Inch version

									s	Dimensions, inch		
DC	CZC _{MS}	APMX	RE	LU	CNSC	CXSC	ZEFP	Ordering code	1745	DCON _{MS}	LF	DN
.250	1/4	1.250	.030	1.406	1	1	5	2F380-0635-076ASD	★	.250	2.938	.237
	1/4	1.250	.060	1.406	1	1	5	2F380-0635-152ASD	★	.250	2.938	.237
.375	3/8	1.875	.030	2.094	1	1	5	2F380-0953-076ASD	★	.375	3.750	.356
	3/8	1.875	.060	2.094	1	1	5	2F380-0953-152ASD	★	.375	3.750	.356
.500	3/8	1.875	.090	2.094	1	1	5	2F380-0953-228ASD	★	.375	3.750	.356
	1/2	2.500	.030	2.781	1	1	5	2F380-1270-076ASD	★	.500	4.688	.475
.500	1/2	2.500	.060	2.781	1	1	5	2F380-1270-152ASD	★	.500	4.688	.475
	1/2	2.500	.090	2.781	1	1	5	2F380-1270-228ASD	★	.500	4.688	.475
.500	1/2	2.500	.120	2.781	1	1	5	2F380-1270-304ASD	★	.500	4.688	.475
	5/8	3.125	.030	3.469	1	1	5	2F380-1588-076ASD	★	.625	5.500	.594
.625	5/8	3.125	.060	3.469	1	1	5	2F380-1588-152ASD	★	.625	5.500	.594
	5/8	3.125	.090	3.469	1	1	5	2F380-1588-228ASD	★	.625	5.500	.594
.625	5/8	3.125	.120	3.469	1	1	5	2F380-1588-304ASD	★	.625	5.500	.594
	3/4	3.781	.030	4.156	1	1	5	2F380-1905-076ASD	★	.750	6.375	.713
.750	3/4	3.781	.060	4.156	1	1	5	2F380-1905-152ASD	★	.750	6.375	.713
	3/4	3.781	.090	4.156	1	1	5	2F380-1905-228ASD	★	.750	6.375	.713
.750	3/4	3.781	.120	4.156	1	1	5	2F380-1905-304ASD	★	.750	6.375	.713
	1	5.031	.030	5.531	1	1	5	2F380-2540-076ASD	★	1.000	8.125	.950
1.000	1	5.031	.060	5.531	1	1	5	2F380-2540-152ASD	★	1.000	8.125	.950
	1	5.031	.090	5.531	1	1	5	2F380-2540-228ASD	★	1.000	8.125	.950
1.000	1	5.031	.120	5.531	1	1	5	2F380-2540-304ASD	★	1.000	8.125	.950

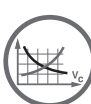

B20



F2



F5



F6



CoroMill® Plura solid carbide end mill for stable multi-operations milling

For Heat resistant super alloys

FHA
BSG
TCDC
TCDCON

50°
DIN 6527 L
h9
h6

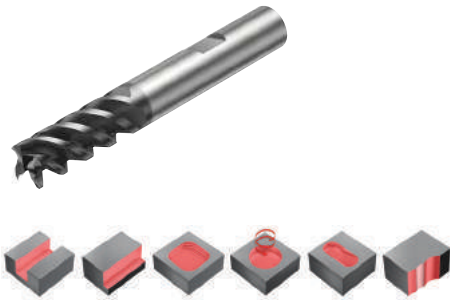
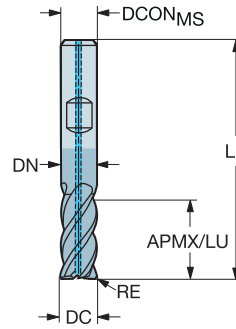

B
Metric version

									s Dimensions, mm			
DC	CZC _{MS}	APMX	RE	LU	CNSC	CXSC	ZEFP	Ordering code	1725	DCON _{MS}	LF	DN
6.0	6	13.0	0.50	19.0	1	1	4	2F440-0600-050ASD	★	6.0	57.0	5.7
	6	13.0	1.00	19.0	1	1	4	2F440-0600-100ASD	★	6.0	57.0	5.7
8.0	8	19.0	0.50	25.0	1	1	4	2F440-0800-050ASD	★	8.0	63.0	7.6
	8	19.0	1.00	25.0	1	1	4	2F440-0800-100ASD	★	8.0	63.0	7.6
10.0	10	22.0	0.50	30.0	1	1	4	2F440-1000-050ASD	★	10.0	72.0	9.5
	10	22.0	1.00	30.0	1	1	4	2F440-1000-100ASD	★	10.0	72.0	9.5
10.0	10	22.0	2.00	30.0	1	1	4	2F440-1000-200ASD	★	10.0	72.0	9.5
	12.0	12	26.0	0.50	36.0	1	1	4	2F440-1200-050ASD	★	12.0	83.0
12.0	12	26.0	1.00	36.0	1	1	4	2F440-1200-100ASD	★	12.0	83.0	11.4
	12	26.0	2.00	36.0	1	1	4	2F440-1200-200ASD	★	12.0	83.0	11.4
16.0	16	32.0	2.00	42.0	1	1	4	2F440-1600-200ASD	★	16.0	92.0	15.2
	16	32.0	3.00	42.0	1	1	4	2F440-1600-300ASD	★	16.0	92.0	15.2
16.0	16	32.0	4.00	42.0	1	1	4	2F440-1600-400ASD	★	16.0	92.0	15.2
	20.0	20	38.0	3.00	52.0	1	1	4	2F440-2000-300ASD	★	20.0	104.0
20.0	20	38.0	4.00	52.0	1	1	4	2F440-2000-400ASD	★	20.0	104.0	19.0
	20	38.0	6.35	52.0	1	1	4	2F440-2000-635ASD	★	20.0	104.0	19.0

D
Inch version

									s Dimensions, inch			
DC	CZC _{MS}	APMX	RE	LU	CNSC	CXSC	ZEFP	Ordering code	1725	DCON _{MS}	LF	DN
.250	1/4	.625	.030	.875	1	1	4	2F440-0635-076ASD	★	.250	2.500	.237
	1/4	.625	.060	.875	1	1	4	2F440-0635-152ASD	★	.250	2.500	.237
.375	3/8	.781	.030	1.156	1	1	4	2F440-0953-076ASD	★	.375	3.000	.356
	3/8	.781	.060	1.156	1	1	4	2F440-0953-152ASD	★	.375	3.000	.356
.375	3/8	.781	.090	1.156	1	1	4	2F440-0953-228ASD	★	.375	3.000	.356
	.500	1/2	1.125	.030	1.438	1	1	4	2F440-1270-076ASD	★	.500	3.500
.500	1/2	1.125	.060	1.438	1	1	4	2F440-1270-152ASD	★	.500	3.500	.475
	1/2	1.125	.090	1.438	1	1	4	2F440-1270-228ASD	★	.500	3.500	.475
.500	1/2	1.125	.120	1.438	1	1	4	2F440-1270-304ASD	★	.500	3.500	.475
	.625	5/8	1.313	.030	1.563	1	1	4	2F440-1588-076ASD	★	.625	3.750
.625	5/8	1.313	.060	1.563	1	1	4	2F440-1588-152ASD	★	.625	3.750	.594
	5/8	1.313	.090	1.563	1	1	4	2F440-1588-228ASD	★	.625	3.750	.594
.625	5/8	1.313	.120	1.563	1	1	4	2F440-1588-304ASD	★	.625	3.750	.594
	.750	3/4	1.625	.030	1.937	1	1	4	2F440-1905-076ASD	★	.750	4.250
.750	3/4	1.625	.060	1.937	1	1	4	2F440-1905-152ASD	★	.750	4.250	.713
	3/4	1.625	.090	1.937	1	1	4	2F440-1905-228ASD	★	.750	4.250	.713
.750	3/4	1.625	.120	1.937	1	1	4	2F440-1905-304ASD	★	.750	4.250	.713

F



CoroMill® Plura solid carbide end mill for stable multi-operations milling

For Heat resistant super alloys

FHA 50°
 BSG DIN 6527 L
 TCDC h9
 TCDCON h6

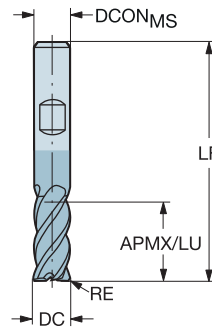
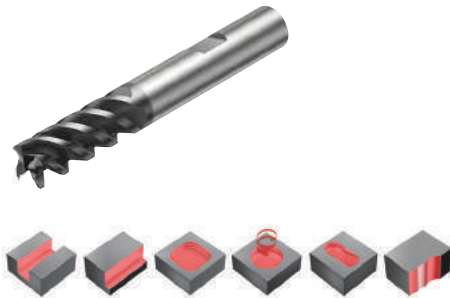

Metric version

							s Dimensions, mm			
DC	CZC _{MS}	APMX	RE	LU	ZEFP	Ordering code	1725	DCON _{MS}	LF	DN
2.0	6	7.0	0.20	9.5	3	2S440-0200-020-SD	★	6.0	57.0	1.9
3.0	6	8.0	0.30	10.0	3	2S440-0300-030-SD	★	6.0	57.0	2.9
4.0	6	11.0	0.50	15.0	3	2S440-0400-050-SD	★	6.0	57.0	3.8
5.0	6	13.0	0.50	16.0	3	2S440-0500-050-SD	★	6.0	57.0	4.8
6.0	6	13.0	0.50	19.0	4	2S440-0600-050-SD	★	6.0	57.0	5.7
	6	13.0	1.00	19.0	4	2S440-0600-100-SD	★	6.0	57.0	5.7
8.0	8	19.0	0.50	25.0	4	2S440-0800-050-SD	★	8.0	63.0	7.6
	8	19.0	1.00	25.0	4	2S440-0800-100-SD	★	8.0	63.0	7.6
10.0	10	22.0	0.50	30.0	4	2S440-1000-050-SD	★	10.0	72.0	9.5
	10	22.0	1.00	30.0	4	2S440-1000-100-SD	★	10.0	72.0	9.5
	10	22.0	2.00	30.0	4	2S440-1000-200-SD	★	10.0	72.0	9.5
12.0	12	26.0	0.50	36.0	4	2S440-1200-050-SD	★	12.0	83.0	11.4
	12	26.0	1.00	36.0	4	2S440-1200-100-SD	★	12.0	83.0	11.4
	12	26.0	2.00	36.0	4	2S440-1200-200-SD	★	12.0	83.0	11.4
16.0	16	32.0	2.00	42.0	4	2S440-1600-200-SD	★	16.0	92.0	15.2
	16	32.0	3.00	42.0	4	2S440-1600-300-SD	★	16.0	92.0	15.2
	16	32.0	4.00	42.0	4	2S440-1600-400-SD	★	16.0	92.0	15.2
20.0	20	38.0	3.00	52.0	4	2S440-2000-300-SD	★	20.0	104.0	19.0
	20	38.0	4.00	52.0	4	2S440-2000-400-SD	★	20.0	104.0	19.0
	20	38.0	6.35	52.0	4	2S440-2000-635-SD	★	20.0	104.0	19.0

Inch version

							s Dimensions, inch			
DC	CZC _{MS}	APMX	RE	LU	ZEFP	Ordering code	1725	DCON _{MS}	LF	DN
.250	1/4	.625	.030	.875	4	2S440-0635-076-SD	★	.250	2.500	.237
	1/4	.625	.060	.875	4	2S440-0635-152-SD	★	.250	2.500	.237
.375	3/8	.781	.030	1.156	4	2S440-0953-076-SD	★	.375	3.000	.356
	3/8	.781	.060	1.156	4	2S440-0953-152-SD	★	.375	3.000	.356
	3/8	.781	.090	1.156	4	2S440-0953-228-SD	★	.375	3.000	.356
.500	1/2	1.125	.030	1.438	4	2S440-1270-076-SD	★	.500	3.500	.475
	1/2	1.125	.060	1.438	4	2S440-1270-152-SD	★	.500	3.500	.475
	1/2	1.125	.090	1.438	4	2S440-1270-228-SD	★	.500	3.500	.475
	1/2	1.125	.120	1.438	4	2S440-1270-304-SD	★	.500	3.500	.475
.625	5/8	1.313	.030	1.563	4	2S440-1588-076-SD	★	.625	3.750	.594
	5/8	1.313	.060	1.563	4	2S440-1588-152-SD	★	.625	3.750	.594
	5/8	1.313	.090	1.563	4	2S440-1588-228-SD	★	.625	3.750	.594
	5/8	1.313	.120	1.563	4	2S440-1588-304-SD	★	.625	3.750	.594
.750	3/4	1.625	.030	1.937	4	2S440-1905-076-SD	★	.750	4.250	.713
	3/4	1.625	.060	1.937	4	2S440-1905-152-SD	★	.750	4.250	.713
	3/4	1.625	.090	1.937	4	2S440-1905-228-SD	★	.750	4.250	.713
	3/4	1.625	.120	1.937	4	2S440-1905-304-SD	★	.750	4.250	.713



B21



F2



F5



F6



CoroMill® Plura solid carbide end mill for stable multi-operations milling

For Heat resistant super alloys

FHA 50°
 BSG DIN 6527 L
 TCDC h9
 TCDCON h6

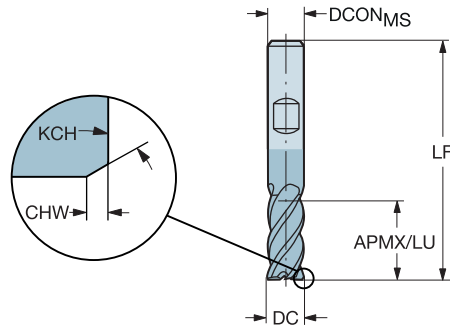
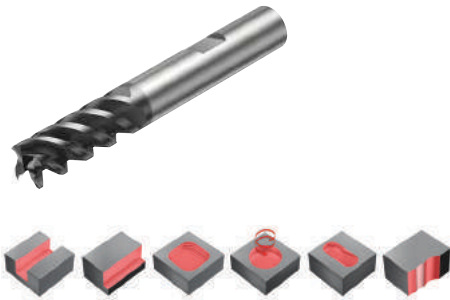

Metric version

								s	Dimensions, mm		
DC	CZC _{MS}	APMX	CHW	KCH	LU	ZEFP	Ordering code	1725	DCON _{MS}	LF	DN
6.0	6	13.0	0.10	45°	19.0	4	2P440-0600-SD	★	6.0	57.0	5.7
8.0	8	19.0	0.10	45°	25.0	4	2P440-0800-SD	★	8.0	63.0	7.6
10.0	10	22.0	0.10	45°	30.0	4	2P440-1000-SD	★	10.0	72.0	9.5
12.0	12	26.0	0.10	45°	36.0	4	2P440-1200-SD	★	12.0	83.0	11.4
16.0	16	32.0	0.15	45°	42.0	4	2P440-1600-SD	★	16.0	92.0	15.2
20.0	20	38.0	0.15	45°	52.0	4	2P440-2000-SD	★	20.0	104.0	19.0

D

E

F



Cutting speed recommendations

Optimized - CoroMill® Plura solid carbide end mill for plunging in nickel-based alloys

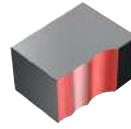

$$a_e = 0.3 \times DC$$

$$a_p = 4 \times DC$$

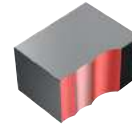



$$a_e = 0.3 \times DC$$

$$a_p = 6 \times DC$$

ISO	MC No.	CMC	Material	HB	f_z mm/tooth	v_c m/min	v_c feet/min	f_z mm/tooth	v_c m/min	v_c feet/min
S	S2.0.Z.AG	20.22	Nickel based super alloys	400	0,02-0,05	25	82	B04	25	82

Cutting speed recommendations

Optimized - CoroMill® Plura solid carbide end mill for high feed side milling in Titanium alloys

												
$a_e = 0.07 \times DC$	$a_e = 0.033 \times DC$	$a_e = 0.2 \text{ mm}$										
$a_p = 5.0 \times DC$	$a_p = 5.0 \times DC$	$a_p = 5.0 \times DC$										
ISO	MC No.	Material	HB	f_z	v_c m/min	v_c feet/min	f_z	v_c m/min	v_c feet/min	f_z	v_c m/min	v_c feet/min
S	S4.3.Z.AN	Alpha/Beta Titanium alloy	330	T01	80	262	T02	120	394	T03	180	590
	S4.4.Z.AN	Beta Titanium alloy	410	T01	60	197	T02	90	295	T03	120	394



Feed recommendations

mm/tooth
inch/tooth

DC	6.000	6.350	8.000	9.525	10.000	12.000	12.700	15.875	16.000	19.050	20.000	25.000	25.400
f_z	0.236	0.250	0.315	0.375	0.394	0.472	0.500	0.625	0.630	0.750	0.787	0.984	1.000
T01	0.020	0.021	0.023	0.023	0.024	0.025	0.025	0.026	0.027	0.027	0.028	0.0292	0.029
	.0008	.0008	.0009	.0009	.0009	.0010	.0010	.0010	.0010	.0011	.0011	.0011	.0012
T02	0.032	0.033	0.036	0.037	0.038	0.040	0.041	0.042	0.042	0.044	0.045	0.0467	0.047
	.0013	.0013	.0014	.0015	.0015	.0016	.0016	.0017	.0017	.0017	.0018	.0018	.0019
T03	0.064	0.067	0.072	0.075	0.077	0.080	0.081	0.085	0.085	0.088	0.089	0.093	0.094
	.0025	.0026	.0028	.0030	.0030	.0031	.0032	.0033	.0033	.0035	.0035	.0037	.0037

Cutting speed recommendations

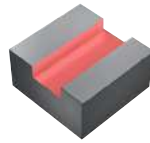
Optimized - CoroMill® Plura solid carbide end mill for stable multi-operations milling in HRSA

												
$a_e = 1.0 \times DC$ $a_p = 0.5 \times DC$			$a_e = 0.5 \times DC$ $a_p = 1.0 \times DC$			$a_e = 0.25 \times DC$ $a_p = 2.0 \times DC$						
ISO	MC No.	Material	HB	f_z	v_c m/min	v_c feet/min	f_z	v_c m/min	v_c feet/min	f_z	v_c m/min	v_c feet/min
S	S1.0.U.AN	Iron based superalloys	200	Z01	30	98	Z01	35	115	Z04	40	131
	S2.0.Z.AN	Nickel based superalloys	250	Z02	22	72	Z02	28	92	Z05	30	98
	S2.0.Z.AG	Nickel based superalloys	400	Z03	17	56	Z03	22	72	Z06	25	82
	S3.0.Z.AN	Cobalt based superalloys	200	Z01	25	82	Z01	30	98	Z04	35	115

Feed recommendations

mm/tooth

inch/tooth

DC	2.000	3.000	4.000	5.000	6.000	6.350	8.000	9.525	10.000	12.000	12.700	15.875	16.000	19.050	20.000
f_z	0.0787	0.1181	0.157	0.197	0.236	0.250	0.315	0.375	0.394	0.472	0.500	0.625	0.630	0.750	0.787
Z01	0.005 .0002	0.008 .0002	0.011 .0004	0.014 .0005	0.016 .0006	0.017 .0007	0.022 .0009	0.026 .0010	0.027 .0011	0.0325 .0013	0.0330 .0013	0.0365 .0014	0.0366 .0014	0.0387 .0015	0.0393 .0015
Z02	0.005 .0002	0.008 .0003	0.010 .0004	0.013 .0005	0.015 .0006	0.016 .0006	0.020 .0008	0.024 .0009	0.025 .0010	0.0300 .0012	0.0305 .0012	0.0337 .0013	0.0338 .0013	0.0357 .0014	0.0363 .0014
Z03	0.004 .0002	0.006 .0004	0.008 .0003	0.010 .0004	0.013 .0005	0.013 .0005	0.017 .0007	0.020 .0008	0.021 .0008	0.0250 .0010	0.0254 .0010	0.0281 .0011	0.0281 .0011	0.0298 .0012	0.0302 .0012
Z04	0.007 .0003	0.010 .0005	0.013 .0005	0.016 .0006	0.020 .0008	0.021 .0008	0.026 .0010	0.031 .0012	0.033 .0013	0.0390 .0015	0.041 .0016	0.052 .0020	0.052 .0020	0.062 .0024	0.065 .0026
Z05	0.006 .0002	0.009 .0004	0.012 .0005	0.015 .0006	0.018 .0007	0.019 .0008	0.024 .0009	0.029 .0011	0.030 .0012	0.0360 .0014	0.038 .0015	0.048 .0019	0.048 .0019	0.057 .0023	0.060 .0024
Z06	0.006 .0002	0.009 .0006	0.012 .0005	0.015 .0006	0.018 .0007	0.019 .0007	0.023 .0009	0.028 .0011	0.029 .0011	0.035 .0014	0.037 .0015	0.046 .0018	0.047 .0018	0.056 .0022	0.058 .0023

Drilling

Indexable drills

CoroDrill® DS20

C2-C5

Cutting data

C6

For complete assortment, see www.sandvik.coromant.com

CoroDrill® DS20 indexable insert drill

Cylindrical shank with flat according to ISO 9766

Internal coolant supply

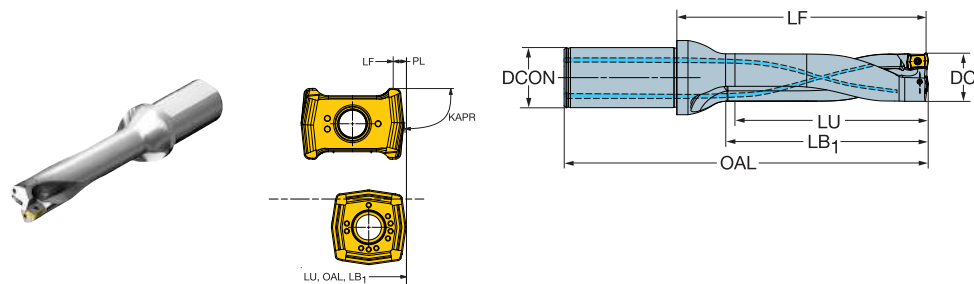

Metric design

										Dimensions, mm								
DC	LU	CZC _{MS}	ADJLX	TCHAL	TCHAU	Ordering code	DCON _{MS}	LF	OAL	LB ₁	PL	KAPR	BAR	NM	KG	RPM		
01C	01P	15.50	62.46	20	1.00	0.00	0.27	DS20-D1550L20-04	20.00	82.53	131.00	63.00	0.46	81°	10	0.6	0.193	24000
			77.96	20	1.00	0.00	0.27	DS20-D1550L20-05	20.00	95.53	146.00	78.00	0.46	81°	10	0.6	0.205	15000
01C	01P	16.50	66.46	20	0.75	0.00	0.27	DS20-D1650L20-04	20.00	84.53	135.00	67.00	0.46	81°	10	0.6	0.203	22000
			82.96	20	0.75	0.00	0.27	DS20-D1650L20-05	20.00	100.53	151.00	83.00	0.46	81°	10	0.6	0.217	14000
01C	01P	17.50	70.46	25	0.50	0.00	0.27	DS20-D1750L25-04	25.00	94.53	151.00	73.00	0.46	81°	10	0.6	0.337	21000
			85.46	25	0.50	0.00	0.27	DS20-D1750L25-05	25.00	105.53	156.00	88.00	0.46	81°	10	0.6	0.353	13000
01C	01P	18.50	72.46	25	0.25	0.00	0.27	DS20-D1850L25-04	25.00	96.53	153.00	75.00	0.46	81°	10	0.6	0.349	20000
			92.96	25	0.25	0.00	0.27	DS20-D1850L25-05	25.00	114.53	171.00	93.00	0.46	81°	10	0.6	0.368	13000
02C	02P	19.50	78.55	25	1.06	0.00	0.33	DS20-D1950L25-04	25.00	100.44	157.00	79.00	0.55	81°	10	0.9	0.362	19000
			98.05	25	1.06	0.00	0.33	DS20-D1950L25-05	25.00	119.44	176.00	98.00	0.55	81°	10	0.9	0.385	12000
06C	06P	41.00	164.00	40	3.73	0.00	0.35	DS20-D4100L40-04	40.00	197.72	269.00	169.00	1.27	81°	10	3.0	1.750	9000
			205.00	40	3.73	0.00	0.35	DS20-D4100L40-05	40.00	238.72	310.00	210.00	1.27	81°	10	3.0	1.961	5000
			246.00	40	3.73	-0.10	0.40	DS20-D4100L40-06	40.00	279.72	351.00	251.00	1.27	81°	10	3.0	2.172	4000
			287.00	40	3.73	-0.10	0.40	DS20-D4100L40-07	40.00	320.72	392.00	292.00	1.27	81°	10	3.0	2.383	3000
06C	06P	42.00	168.00	50	3.46	0.00	0.35	DS20-D4200L50-04	50.00	208.72	290.00	173.00	1.27	81°	10	3.0	2.578	8000
			210.00	50	3.46	0.00	0.35	DS20-D4200L50-05	50.00	250.72	332.00	215.00	1.27	81°	10	3.0	2.805	5000
			252.00	50	3.46	-0.10	0.40	DS20-D4200L50-06	50.00	292.72	374.00	257.00	1.27	81°	10	3.0	3.033	4000
			294.00	50	3.46	-0.10	0.40	DS20-D4200L50-07	50.00	334.72	416.00	299.00	1.27	81°	10	3.0	3.260	2000
06C	06P	43.00	172.00	50	3.19	0.00	0.35	DS20-D4300L50-04	50.00	212.72	294.00	177.00	1.27	81°	10	3.0	2.654	8000
			215.00	50	3.19	0.00	0.35	DS20-D4300L50-05	50.00	255.72	337.00	220.00	1.27	81°	10	3.0	2.898	5000
			258.00	50	3.19	-0.10	0.40	DS20-D4300L50-06	50.00	298.72	380.00	263.00	1.27	81°	10	3.0	3.143	3000
			301.00	50	3.19	-0.10	0.40	DS20-D4300L50-07	50.00	341.72	423.00	306.00	1.27	81°	10	3.0	3.388	2000
06C	06P	44.00	176.00	50	2.92	0.00	0.35	DS20-D4400L50-04	50.00	216.72	298.00	181.00	1.27	81°	10	3.0	2.733	8000
			220.00	50	2.92	0.00	0.35	DS20-D4400L50-05	50.00	260.72	342.00	225.00	1.27	81°	10	3.0	2.996	5000
			264.00	50	2.92	-0.10	0.40	DS20-D4400L50-06	50.00	304.72	386.00	269.00	1.27	81°	10	3.0	3.259	3000
			308.00	50	2.92	-0.10	0.40	DS20-D4400L50-07	50.00	348.72	430.00	313.00	1.27	81°	10	3.0	3.521	2000
06C	06P	45.00	180.00	50	2.65	0.00	0.35	DS20-D4500L50-04	50.00	220.72	302.00	185.00	1.27	81°	10	3.0	2.816	8000
			225.00	50	2.65	0.00	0.35	DS20-D4500L50-05	50.00	265.72	347.00	230.00	1.27	81°	10	3.0	3.101	5000
			270.00	50	2.65	-0.10	0.40	DS20-D4500L50-06	50.00	310.72	392.00	275.00	1.27	81°	10	3.0	3.385	3000
			315.00	50	2.65	-0.10	0.40	DS20-D4500L50-07	50.00	355.72	437.00	320.00	1.27	81°	10	3.0	3.669	2000
06C	06P	46.00	184.00	50	2.38	0.00	0.35	DS20-D4600L50-04	50.00	224.72	306.00	189.00	1.27	81°	10	3.0	2.902	8000
			230.00	50	2.38	0.00	0.35	DS20-D4600L50-05	50.00	270.72	352.00	235.00	1.27	81°	10	3.0	3.206	5000
06C	06P	47.00	188.00	50	2.11	0.00	0.35	DS20-D4700L50-04	50.00	227.72	309.00	193.00	1.27	81°	10	3.0	2.968	8000
			235.00	50	2.11	0.00	0.35	DS20-D4700L50-05	50.00	274.72	356.00	240.00	1.27	81°	10	3.0	3.293	5000
06C	06P	48.00	192.00	50	1.84	0.00	0.35	DS20-D4800L50-04	50.00	231.72	313.00	197.00	1.27	81°	10	3.0	3.061	7000
			240.00	50	1.84	0.00	0.35	DS20-D4800L50-05	50.00	279.72	361.00	245.00	1.27	81°	10	3.0	3.408	5000
06C	06P	49.00	196.00	50	1.57	0.00	0.35	DS20-D4900L50-04	50.00	235.72	317.00	201.00	1.27	81°	10	3.0	3.158	7000
			245.00	50	1.57	0.00	0.35	DS20-D4900L50-05	50.00	284.72	366.00	250.00	1.27	81°	10	3.0	3.528	4000
06C	06P	50.00	200.00	50	1.30	0.00	0.35	DS20-D5000L50-04	50.00	239.72	321.00	205.00	1.27	81°	10	3.0	3.259	7000
			250.00	50	1.30	0.00	0.35	DS20-D5000L50-05	50.00	289.72	371.00	255.00	1.27	81°	10	3.0	3.652	4000

	Spare parts
DC	Insert screw
15.50-18.50	5513 020-27
19.50	5513 020-88
41.00-65.00	416.1-834

For complete list of spare parts, see www.sandvik.coromant.com



C5



F2



F5

CoroDrill® DS20 indexable insert drill

Cylindrical shank with flat according to ISO 9766

Internal coolant supply

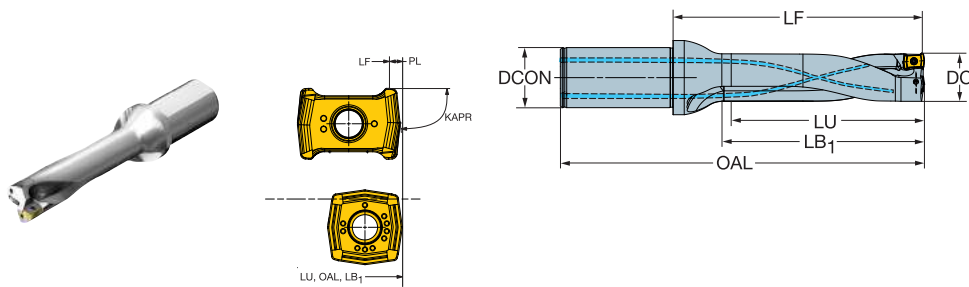

Metric design

									Dimensions, mm									
DC	LU	CZC _{MS}	ADJLX	TCHAL	TCHAU	Ordering code	DCON _{MS}	LF	OAL	LB ₁	PL	KAPR	BAR	NM	KG	RPMX		
06C	06P	51.00	204.00	50	1.03	0.00	DS20-D5100L50-04	50.00	243.72	325.00	209.00	1.27	81°	10	3.0	3.363	7000	
		255.00	50	1.03	0.00	0.35	DS20-D5100L50-05	50.00	294.72	376.00	260.00	1.27	81°	10	3.0	3.781	4000	
06C	06P	52.00	208.00	50	0.76	0.00	0.35	DS20-D5200L50-04	50.00	247.72	329.00	213.00	1.27	81°	10	3.0	3.472	7000
		260.00	50	0.76	0.00	0.35	DS20-D5200L50-05	50.00	299.72	381.00	265.00	1.27	81°	10	3.0	3.916	4000	
07C	07P	53.00	212.00	50	4.21	0.00	0.35	DS20-D5300L50-04	50.00	251.41	333.00	217.00	1.58	81°	10	3.0	3.459	7000
		265.00	50	4.21	0.00	0.35	DS20-D5300L50-05	50.00	304.41	386.00	270.00	1.58	81°	10	3.0	3.911	4000	
07C	07P	54.00	216.00	50	3.92	0.00	0.35	DS20-D5400L50-04	50.00	255.41	337.00	221.00	1.58	81°	10	3.0	3.573	7000
		270.00	50	3.92	0.00	0.35	DS20-D5400L50-05	50.00	309.41	391.00	275.00	1.58	81°	10	3.0	4.052	4000	
07C	07P	55.00	220.00	50	3.63	0.00	0.35	DS20-D5500L50-04	50.00	259.41	341.00	225.00	1.58	81°	10	3.0	3.694	6000
		275.00	50	3.63	0.00	0.35	DS20-D5500L50-05	50.00	314.41	396.00	280.00	1.58	81°	10	3.0	4.202	4000	
07C	07P	56.00	224.00	50	3.34	0.00	0.35	DS20-D5600L50-04	50.00	263.41	345.00	229.00	1.58	81°	10	3.0	3.827	6000
		280.00	50	3.34	0.00	0.35	DS20-D5600L50-05	50.00	319.41	401.00	285.00	1.58	81°	10	3.0	4.367	4000	
07C	07P	57.00	228.00	50	3.05	0.00	0.35	DS20-D5700L50-04	50.00	267.41	349.00	233.00	1.58	81°	10	3.0	3.957	6000
		285.00	50	3.05	0.00	0.35	DS20-D5700L50-05	50.00	324.41	406.00	290.00	1.58	81°	10	3.0	4.528	4000	
07C	07P	58.00	232.00	50	2.76	0.00	0.35	DS20-D5800L50-04	50.00	271.41	353.00	237.00	1.58	81°	10	3.0	4.300	6000
		290.00	50	2.76	0.00	0.35	DS20-D5800L50-05	50.00	329.41	411.00	295.00	1.58	81°	10	3.0	4.623	4000	
07C	07P	59.00	236.00	50	2.47	0.00	0.35	DS20-D5900L50-04	50.00	274.41	356.00	241.00	1.58	81°	10	3.0	4.146	6000
		295.00	50	2.47	0.00	0.35	DS20-D5900L50-05	50.00	333.41	415.00	300.00	1.58	81°	10	3.0	4.768	4000	
07C	07P	60.00	240.00	50	2.18	0.00	0.35	DS20-D6000L50-04	50.00	278.41	360.00	245.00	1.58	81°	10	3.0	4.350	6000
		300.00	50	2.18	0.00	0.35	DS20-D6000L50-05	50.00	338.41	420.00	305.00	1.58	81°	10	3.0	5.021	4000	
07C	07P	61.00	244.00	50	1.89	0.00	0.35	DS20-D6100L50-04	50.00	282.41	364.00	249.00	1.58	81°	10	3.0	4.498	6000
		305.00	50	1.89	0.00	0.35	DS20-D6100L50-05	50.00	343.41	425.00	310.00	1.58	81°	10	3.0	5.204	4000	
07C	07P	62.00	248.00	50	1.60	0.00	0.35	DS20-D6200L50-04	50.00	286.41	368.00	253.00	1.58	81°	10	3.0	4.651	6000
		310.00	50	1.60	0.00	0.35	DS20-D6200L50-05	50.00	348.41	430.00	315.00	1.58	81°	10	3.0	5.393	3000	
07C	07P	63.00	252.00	50	1.31	0.00	0.35	DS20-D6300L50-04	50.00	290.41	372.00	257.00	1.58	81°	10	3.0	4.806	6000
		315.00	50	1.31	0.00	0.35	DS20-D6300L50-05	50.00	353.41	435.00	320.00	1.58	81°	10	3.0	5.587	3000	
07C	07P	64.00	256.00	50	1.02	0.00	0.35	DS20-D6400L50-04	50.00	295.41	377.00	261.00	1.58	81°	10	3.0	4.848	5000
		320.00	50	1.02	0.00	0.35	DS20-D6400L50-05	50.00	359.41	441.00	325.00	1.58	81°	10	3.0	5.633	3000	
07C	07P	65.00	260.00	50	0.73	0.00	0.35	DS20-D6500L50-04	50.00	299.41	381.00	265.00	1.58	81°	10	3.0	5.167	5000
		325.00	50	0.73	0.00	0.35	DS20-D6500L50-05	50.00	364.41	446.00	330.00	1.58	81°	10	3.0	6.027	3000	

Spare parts	
DC	Insert screw
15.50-18.50	5513 020-27
19.50	5513 020-88
41.00-65.00	416.1-834

For complete list of spare parts, see www.sandvik.coromant.com



CoroDrill® DS20 indexable insert drill

Cylindrical shank with flat according to ISO 9766

Internal coolant supply

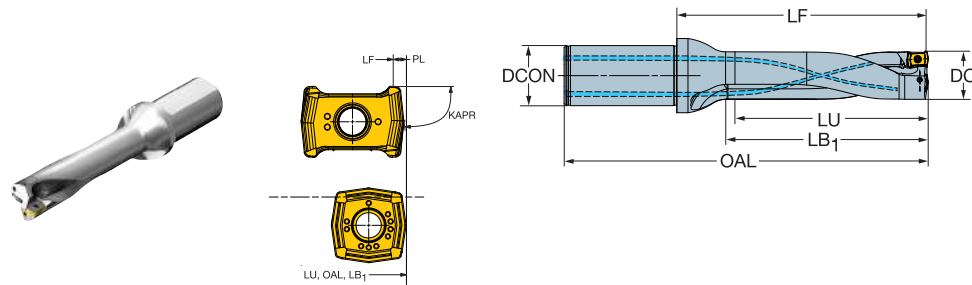

Inch design

		Dimensions, inch																
DC	LU	CZC _{MS}	ADJLX	TCHAL	TCHAU	Ordering code	DCON _{MS}	LF	OAL	LB ₁	PL	KAPR	PSI	FT/LBS	LBS	RPMX		
06C	06P	1.625	6.500	1 1/2	.143	.000	.014	DS20-D4128LX38-04	1.500	7.770	10.576	6.666	.050	81°	145	2.2	3.968	9000
		8.125	1 1/2	.143	.000	.014	DS20-D4128LX38-05	1.500	9.395	12.201	8.291	.050	81°	145	2.2	4.409	5000	
		9.750	1 1/2	.143	-.004	.016	DS20-D4128LX38-06	1.500	11.020	13.826	9.916	.050	81°	145	2.2	5.511	4000	
		11.375	1 1/2	.143	-.004	.016	DS20-D4128LX38-07	1.500	12.645	15.451	11.541	.050	81°	145	2.2	5.952	3000	
06C	06P	1.687	6.748	1 1/2	.127	.000	.014	DS20-D4285LX38-04	1.500	8.013	10.819	6.914	.050	81°	145	2.2	4.409	8000
		8.435	1 1/2	.127	.000	.014	DS20-D4285LX38-05	1.500	9.700	12.506	8.601	.050	81°	145	2.2	4.629	5000	
		10.122	1 1/2	.127	-.004	.016	DS20-D4285LX38-06	1.500	11.387	14.193	10.288	.050	81°	145	2.2	5.952	3000	
		11.809	1 1/2	.127	-.004	.016	DS20-D4285LX38-07	1.500	13.074	15.880	11.975	.050	81°	145	2.2	6.393	2000	
06C	06P	1.750	7.000	1 1/2	.110	.000	.014	DS20-D4445LX38-04	1.500	8.260	11.066	7.166	.050	81°	145	2.2	4.409	8000
		8.750	1 1/2	.110	.000	.014	DS20-D4445LX38-05	1.500	10.010	12.816	8.916	.050	81°	145	2.2	4.841	5000	
		10.500	1 1/2	.110	-.004	.016	DS20-D4445LX38-06	1.500	11.760	14.566	10.666	.050	81°	145	2.2	6.172	3000	
		12.250	1 1/2	.110	-.004	.016	DS20-D4445LX38-07	1.500	13.510	16.316	12.416	.050	81°	145	2.2	6.038	2000	
06C	06P	1.875	7.500	1 1/2	.076	.000	.014	DS20-D4763LX38-04	1.500	8.750	11.556	7.666	.050	81°	145	2.2	5.070	7000
		9.375	1 1/2	.076	.000	.014	DS20-D4763LX38-05	1.500	10.625	13.431	9.541	.050	81°	145	2.2	6.393	5000	
06C	06P	2.000	8.000	1 1/2	.042	.000	.014	DS20-D5080LX38-04	1.500	9.520	12.326	8.166	.050	81°	145	2.2	6.172	7000
		10.000	1 1/2	.042	.000	.014	DS20-D5080LX38-05	1.500	11.520	14.326	10.166	.050	81°	145	2.2	7.716	4000	
07C	07P	2.125	8.500	1 1/2	.154	.000	.014	DS20-D5398LX38-04	1.500	10.009	12.828	8.678	.063	81°	145	2.2	6.530	7000
		10.625	1 1/2	.154	.000	.014	DS20-D5398LX38-05	1.500	12.134	14.953	10.803	.063	81°	145	2.2	8.377	4000	
07C	07P	2.250	9.000	1 1/2	.118	.000	.014	DS20-D5715LX38-04	1.500	10.499	13.318	9.178	.063	81°	145	2.2	7.414	6000
		11.250	1 1/2	.118	.000	.014	DS20-D5715LX38-05	1.500	12.749	15.568	11.428	.063	81°	145	2.2	9.259	4000	
07C	07P	2.375	9.500	1 1/2	.082	.000	.014	DS20-D6033LX38-04	1.500	10.989	13.808	9.678	.063	81°	145	2.2	8.377	6000
		11.875	1 1/2	.082	.000	.014	DS20-D6033LX38-05	1.500	13.364	16.183	12.053	.063	81°	145	2.2	10.582	4000	
07C	07P	2.500	10.000	1 1/2	.045	.000	.014	DS20-D6350LX38-04	1.500	11.480	14.299	10.178	.063	81°	145	2.2	9.389	6000
		12.500	1 1/2	.045	.000	.014	DS20-D6350LX38-05	1.500	13.980	16.799	12.678	.063	81°	145	2.2	11.905	3000	

Spare parts
Insert screw
416.1-834

For complete list of spare parts, see www.sandvik.coromant.com



CoroDrill® DS20 insert for drilling

Central insert

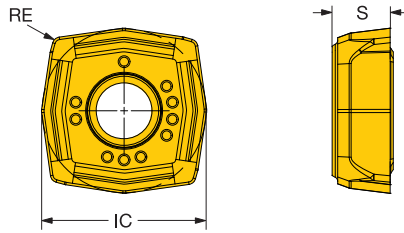

INSUC	Ordering code	P	M	K	N	S	H	Dimensions, mm, inch			
		1344	1144	1344	H13A	1344	H13A	1344	S	RE	IC
06	C DS20-0608-C-L5	★	★		★	☆	★	★	3.90	0.35	17.5
									.154	.014	.687
06	C DS20-0608-C-M7	★		★				☆	3.90	0.35	17.5
									.154	.014	.687
07	C DS20-0708-C-L5	★	★		★	☆	★	★	4.50	0.35	21.8
									.177	.014	.859
07	C DS20-0708-C-M7	★		★				☆	4.50	0.35	21.8
									.177	.014	.859

Peripheral insert

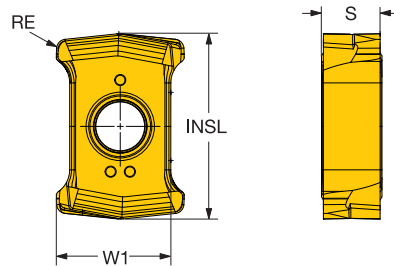

INSUC	Ordering code	P	M	K	N	S	H	Dimensions, mm, inch												
		4324	4334	4344	2044	4334	4344	4324	4334	4344	H13A	2044	4344	H13A	4334	4344	S	RE	W1	INSL
06	P DS20-0608-P-H5W		★	☆	★	☆	☆										6.20	0.80	14.4	19.4
																	.244	.031	.568	.764
06	P DS20-0608-P-L5W	☆	★	☆	★	☆	☆			★	★	☆					6.20	0.80	14.4	19.4
																	.244	.031	.568	.764
06	P DS20-0608-P-L6W			★				★	★			★					6.20	0.80	14.4	19.4
																	.244	.031	.568	.764
06	P DS20-0608-P-M7W	☆	★	☆				☆	★	☆							6.20	0.80	14.4	19.4
																	.244	.031	.568	.764
06	P DS20-0608-P-S5W				★			☆	★		★	☆					6.20	0.80	14.4	19.4
																	.244	.031	.568	.764
07	P DS20-0708-P-H5W		★	☆	★	☆	☆										7.00	0.80	18.0	21.9
																	.276	.031	.710	.862
07	P DS20-0708-P-L5W	☆	★	☆	★	☆	☆			★	★	☆					7.00	0.80	18.0	21.9
																	.276	.031	.710	.862
07	P DS20-0708-P-L6W			★				★	★			★					7.00	0.80	18.0	21.9
																	.276	.031	.710	.862
07	P DS20-0708-P-M7W	☆	★	☆				☆	★	☆							7.00	0.80	18.0	21.9
																	.276	.031	.710	.862
07	P DS20-0708-P-S5W				★			☆	★		★	☆					7.00	0.80	18.0	21.9
																	.276	.031	.710	.862



C2



C6



F2

CoroDrill® DS20

4-5xD

Metric values

ISO	MC No.	Material	HB	Grade	Cutting speed recommendations			Drill diameter	Drill length 4xD					Drill length 5xD					
									-S5W	-L5W	-L6W	-M7W	-H5W	-S5W	-L5W	-L6W	-M7W	-H5W	
					4-5xD										Recommended start value at middle of feed range				
P	P3.0.Z.HT	High alloy steel Hardened and tempered	380	4324	80	165	210	15.00-18.00	-	-	0.06-0.14	0.06-0.16	-	-	-	0.06-0.12	0.06-0.14	-	
				4334	75	140	175	18.01-22.00	-	-	0.06-0.16	0.06-0.18	-	-	-	0.06-0.14	0.06-0.15	-	
				4344	70	110	130	22.01-27.00	-	-	0.06-0.2	0.06-0.22	-	-	-	0.06-0.17	0.06-0.19	-	
								27.01-33.00	-	-	0.08-0.24	0.08-0.26	-	-	-	0.08-0.2	0.08-0.22	-	
								33.01-40.00	-	-	0.08-0.26	0.08-0.28	-	-	-	0.08-0.22	0.08-0.24	-	
								40.01-52.00	-	-	0.1-0.26	0.1-0.28	-	-	-	0.1-0.22	0.1-0.24	-	
					52.01-65.00	-	-	0.1-0.26	0.1-0.28	-	-	-	0.1-0.22	0.1-0.24	-				
	P5.0.Z.AN	Ferritic/martensitic stainless steel Annealed	200	4334	115	185	225	15.00-18.00	0.05-0.13	0.05-0.13	0.05-0.13	-	0.05-0.12	0.05-0.11	0.05-0.11	0.05-0.11	-	0.05-0.1	
				4344	115	155	175	18.01-22.00	0.05-0.14	0.05-0.14	0.05-0.14	-	0.05-0.13	0.05-0.12	0.05-0.12	0.05-0.12	-	0.05-0.11	
				2044	115	150	165	22.01-27.00	0.05-0.15	0.05-0.15	0.05-0.15	-	0.05-0.14	0.05-0.13	0.05-0.13	0.05-0.13	-	0.05-0.12	
								27.01-33.00	0.07-0.16	0.07-0.16	0.07-0.16	-	0.07-0.15	0.07-0.14	0.07-0.14	0.07-0.14	-	0.07-0.13	
								33.01-40.00	0.07-0.18	0.07-0.18	0.07-0.18	-	0.07-0.16	0.07-0.15	0.07-0.15	0.07-0.15	-	0.07-0.14	
							40.01-52.00	0.09-0.18	0.09-0.18	0.09-0.18	-	0.09-0.16	0.09-0.15	0.09-0.15	0.09-0.15	-	0.09-0.14		
				52.01-65.00	0.09-0.18	0.09-0.18	0.09-0.18	-	0.09-0.16	0.09-0.15	0.09-0.15	0.09-0.15	-	0.09-0.14					
P5.0.Z.HT	Ferritic/martensitic stainless steel Hardened and tempered	330	4334	75	135	170	15.00-18.00	0.05-0.13	0.05-0.13	0.05-0.13	-	0.05-0.12	0.05-0.11	0.05-0.11	0.05-0.11	-	0.05-0.1		
			4344	70	115	140	18.01-22.00	0.05-0.14	0.05-0.14	0.05-0.14	-	0.05-0.13	0.05-0.12	0.05-0.12	0.05-0.12	-	0.05-0.11		
			2044	70	115	140	22.01-27.00	0.05-0.15	0.05-0.15	0.05-0.15	-	0.05-0.14	0.05-0.13	0.05-0.13	0.05-0.13	-	0.05-0.12		
							27.01-33.00	0.07-0.16	0.07-0.16	0.07-0.16	-	0.07-0.15	0.07-0.14	0.07-0.14	0.07-0.14	-	0.07-0.13		
							33.01-40.00	0.07-0.18	0.07-0.18	0.07-0.18	-	0.07-0.16	0.07-0.15	0.07-0.15	0.07-0.15	-	0.07-0.14		
							40.01-52.00	0.09-0.18	0.09-0.18	0.09-0.18	-	0.09-0.16	0.09-0.15	0.09-0.15	0.09-0.15	-	0.09-0.14		
				52.01-65.00	0.09-0.18	0.09-0.18	0.09-0.18	-	0.09-0.16	0.09-0.15	0.09-0.15	0.09-0.15	-	0.09-0.14					
M	M1.0.Z.AQ	Austenitic stainless steel Annealed/quenched	200	4334	115	185	225	15.00-18.00	0.05-0.12	0.05-0.12	0.05-0.12	-	0.05-0.11	0.05-0.11	0.05-0.11	0.05-0.11	-	0.05-0.1	
				4344	115	165	190	18.01-22.00	0.05-0.13	0.05-0.13	0.05-0.13	-	0.05-0.12	0.05-0.12	0.05-0.12	0.05-0.12	-	0.05-0.11	
				2044	115	155	180	22.01-27.00	0.05-0.14	0.05-0.14	0.05-0.14	-	0.05-0.13	0.05-0.13	0.05-0.13	0.05-0.13	-	0.05-0.12	
								27.01-33.00	0.07-0.15	0.07-0.15	0.07-0.15	-	0.07-0.14	0.07-0.14	0.07-0.14	0.07-0.14	-	0.07-0.13	
								33.01-40.00	0.07-0.16	0.07-0.16	0.07-0.16	-	0.07-0.15	0.07-0.14	0.07-0.14	0.07-0.14	-	0.07-0.13	
								40.01-52.00	0.09-0.16	0.09-0.16	0.09-0.16	-	0.09-0.15	0.09-0.14	0.09-0.14	0.09-0.14	-	0.09-0.13	
					52.01-65.00	0.09-0.16	0.09-0.16	0.09-0.16	-	0.09-0.15	0.09-0.14	0.09-0.14	0.09-0.14	-	0.09-0.13				
	M1.1.Z.AQ	Austenitic stainless steel Machinability improved	200	4334	115	195	240	15.00-18.00	0.05-0.12	0.05-0.12	0.05-0.12	-	0.05-0.11	0.05-0.11	0.05-0.11	0.05-0.11	-	0.05-0.1	
				4344	115	175	210	18.01-22.00	0.05-0.13	0.05-0.13	0.05-0.13	-	0.05-0.12	0.05-0.12	0.05-0.12	0.05-0.12	-	0.05-0.11	
				2044	115	170	200	22.01-27.00	0.05-0.14	0.05-0.14	0.05-0.14	-	0.05-0.13	0.05-0.13	0.05-0.13	0.05-0.13	-	0.05-0.12	
								27.01-33.00	0.07-0.15	0.07-0.15	0.07-0.15	-	0.07-0.14	0.07-0.14	0.07-0.14	0.07-0.14	-	0.07-0.13	
								33.01-40.00	0.07-0.16	0.07-0.16	0.07-0.16	-	0.07-0.15	0.07-0.14	0.07-0.14	0.07-0.14	-	0.07-0.13	
							40.01-52.00	0.09-0.16	0.09-0.16	0.09-0.16	-	0.09-0.15	0.09-0.14	0.09-0.14	0.09-0.14	-	0.09-0.13		
				52.01-65.00	0.09-0.16	0.09-0.16	0.09-0.16	-	0.09-0.15	0.09-0.14	0.09-0.14	0.09-0.14	-	0.09-0.13					
M2.0.Z.AQ	Super austenitic (N>20%) stainless steel Annealed/quenched	200	4334	80	125	150	15.00-18.00	0.05-0.12	0.05-0.12	0.05-0.12	-	0.05-0.11	0.05-0.11	0.05-0.11	0.05-0.11	-	0.05-0.1		
			4344	80	110	125	18.01-22.00	0.05-0.13	0.05-0.13	0.05-0.13	-	0.05-0.12	0.05-0.12	0.05-0.12	0.05-0.12	-	0.05-0.11		
			2044	80	110	125	22.01-27.00	0.05-0.14	0.05-0.14	0.05-0.14	-	0.05-0.13	0.05-0.13	0.05-0.13	0.05-0.13	-	0.05-0.12		
							27.01-33.00	0.07-0.15	0.07-0.15	0.07-0.15	-	0.07-0.14	0.07-0.14	0.07-0.14	0.07-0.14	-	0.07-0.13		
							33.01-40.00	0.07-0.16	0.07-0.16	0.07-0.16	-	0.07-0.15	0.07-0.14	0.07-0.14	0.07-0.14	-	0.07-0.13		
							40.01-52.00	0.09-0.16	0.09-0.16	0.09-0.16	-	0.09-0.15	0.09-0.14	0.09-0.14	0.09-0.14	-	0.09-0.13		
				52.01-65.00	0.09-0.16	0.09-0.16	0.09-0.16	-	0.09-0.15	0.09-0.14	0.09-0.14	0.09-0.14	-	0.09-0.13					
M3.1.Z.AQ	Duplex stainless steel >60% ferrite (N<0.10%)	230	4334	85	125	145	15.00-18.00	0.05-0.12	0.05-0.12	0.05-0.12	-	0.05-0.11	0.05-0.11	0.05-0.11	0.05-0.11	-	0.05-0.1		
			4344	85	115	130	18.01-22.00	0.05-0.13	0.05-0.13	0.05-0.13	-	0.05-0.12	0.05-0.12	0.05-0.12	0.05-0.12	-	0.05-0.11		
			2044	85	110	125	22.01-27.00	0.05-0.14	0.05-0.14	0.05-0.14	-	0.05-0.13	0.05-0.13	0.05-0.13	0.05-0.13	-	0.05-0.12		
							27.01-33.00	0.07-0.15	0.07-0.15	0.07-0.15	-	0.07-0.14	0.07-0.14	0.07-0.14	0.07-0.14	-	0.07-0.13		
							33.01-40.00	0.07-0.16	0.07-0.16	0.07-0.16	-	0.07-0.15	0.07-0.14	0.07-0.14	0.07-0.14	-	0.07-0.13		
							40.01-52.00	0.09-0.16	0.09-0.16	0.09-0.16	-	0.09-0.15	0.09-0.14	0.09-0.14	0.09-0.14	-	0.09-0.13		
				52.01-65.00	0.09-0.16	0.09-0.16	0.09-0.16	-	0.09-0.15	0.09-0.14	0.09-0.14	0.09-0.14	-	0.09-0.13					
M3.2.Z.AQ	Duplex stainless steel <60% ferrite (N>0.10%)	260	4334	75	105	120	15.00-18.00	0.05-0.12	0.05-0.12	0.05-0.12	-	0.05-0.11	0.05-0.11	0.05-0.11	0.05-0.11	-	0.05-0.1		
			4344	75	100	115	18.01-22.00	0.05-0.13	0.05-0.13	0.05-0.13	-	0.05-0.12	0.05-0.12	0.05-0.12	0.05-0.12	-	0.05-0.11		
			2044	75	100	115	22.01-27.00	0.05-0.14	0.05-0.14	0.05-0.14	-	0.05-0.13	0.05-0.13	0.05-0.13	0.05-0.13	-	0.05-0.12		
							27.01-33.00	0.07-0.15	0.07-0.15	0.07-0.15	-	0.07-0.14	0.07-0.14	0.07-0.14	0.07-0.14	-	0.07-0.13		
							33.01-40.00	0.07-0.16	0.07-0.16	0.07-0.16	-	0.07-0.15	0.07-0.14	0.07-0.14	0.07-0.14	-	0.07-0.13		
							40.01-52.00	0.09-0.16	0.09-0.16	0.09-0.16	-	0.09-0.15	0.09-0.14	0.09-0.14	0.09-0.14	-	0.09-0.13		
				52.01-65.00	0.09-0.16	0.09-0.16	0.09-0.16	-	0.09-0.15	0.09-0.14	0.09-0.14	0.09-0.14	-	0.09-0.13					
S	S2.0.Z.AN S2.0.Z.AG S2.0.Z.NS	Heat resistant super alloys Ni based	350	4334	20	40	50	15.00-18.00	0.04-0.08	0.04-0.08	0.04-0.08	-	-	0.04-0.07	0.04-0.07	0.04-0.07	-		
				4344	20	40	50	18.01-22.00	0.04-0.09	0.04-0.09	0.04-0.09	-	-	0.04-0.08	0.04-0.08	0.04-0.08	-		
				2044	20	40	50	22.01-27.00	0.04-0.1	0.04-0.1	0.04-0.1	-	-	0.04-0.09	0.04-0.09	0.04-0.09	-		
								27.01-33.00	0.05-0.11	0.05-0.11	0.05-0.11	-	-	0.05-0.1	0.05-0.1	0.05-0.1	-		
								33.01-40.00	0.05-0.12	0.05-0.12	0.05-0.12	-	-	0.05-0.11	0.05-0.11	0.05-0.11	-		
								40.01-52.00	0.06-0.12	0.06-0.12	0.06-0.12	-	-	0.06-0.11	0.06-0.11				

CoroDrill® DS20

4-5xD

Metric values

ISO	MC No.	Material	HB	Grade	Cutting speed recommendations			Drill diameter	Drill length 4xD					Drill length 5xD				
					4-5xD	-S5W	-L5W		-L6W	-M7W	-H5W	-S5W	-L5W	-L6W	-M7W	-H5W		
K	K1.1.C.NS	Malleable cast iron Low tensile strength	200	4324	140	210	245	15.00-18.00	-	0.08-0.15	0.08-0.15	0.08-0.2	-	-	0.08-0.13	0.08-0.13	0.08-0.17	-
				4334	110	170	200	18.01-22.00	-	0.08-0.18	0.08-0.18	0.08-0.23	-	-	0.08-0.15	0.08-0.15	0.08-0.2	-
				4344	180	165	155	22.01-27.00	-	0.08-0.21	0.08-0.21	0.08-0.26	-	-	0.08-0.18	0.08-0.18	0.08-0.22	-
								27.01-33.00	-	0.1-0.24	0.1-0.24	0.1-0.29	-	-	0.1-0.2	0.1-0.2	0.1-0.25	-
								33.01-40.00	-	0.1-0.27	0.1-0.27	0.1-0.32	-	-	0.1-0.23	0.1-0.23	0.1-0.27	-
								40.01-52.00	-	0.12-0.27	0.12-0.27	0.12-0.32	-	-	0.12-0.23	0.12-0.23	0.12-0.27	-
					52.01-65.00	-	0.12-0.27	0.12-0.27	0.12-0.32	-	-	0.12-0.23	0.12-0.23	0.12-0.27	-			
	K2.1.C.UT	Grey cast iron Low tensile strength	180	4324	210	285	325	15.00-18.00	-	0.08-0.15	0.08-0.15	0.08-0.2	-	-	0.08-0.13	0.08-0.13	0.08-0.17	-
				4334	170	235	270	18.01-22.00	-	0.08-0.18	0.08-0.18	0.08-0.23	-	-	0.08-0.15	0.08-0.15	0.08-0.2	-
				4344	130	180	205	22.01-27.00	-	0.08-0.21	0.08-0.21	0.08-0.26	-	-	0.08-0.18	0.08-0.18	0.08-0.22	-
								27.01-33.00	-	0.1-0.24	0.1-0.24	0.1-0.29	-	-	0.1-0.2	0.1-0.2	0.1-0.25	-
								33.01-40.00	-	0.1-0.27	0.1-0.27	0.1-0.32	-	-	0.1-0.23	0.1-0.23	0.1-0.27	-
								40.01-52.00	-	0.12-0.27	0.12-0.27	0.12-0.32	-	-	0.12-0.23	0.12-0.23	0.12-0.27	-
					52.01-65.00	-	0.12-0.27	0.12-0.27	0.12-0.32	-	-	0.12-0.23	0.12-0.23	0.12-0.27	-			
	K2.2.C.UT	Grey cast iron High tensile strength	245	4324	125	205	245	15.00-18.00	-	0.08-0.13	0.08-0.13	0.08-0.18	-	-	0.08-0.11	0.08-0.11	0.08-0.15	-
				4334	100	160	195	18.01-22.00	-	0.08-0.16	0.08-0.16	0.08-0.21	-	-	0.08-0.14	0.08-0.14	0.08-0.18	-
				4344	75	125	150	22.01-27.00	-	0.08-0.19	0.08-0.19	0.08-0.24	-	-	0.08-0.16	0.08-0.16	0.08-0.2	-
								27.01-33.00	-	0.1-0.22	0.1-0.22	0.1-0.27	-	-	0.1-0.19	0.1-0.19	0.1-0.23	-
								33.01-40.00	-	0.1-0.25	0.1-0.25	0.1-0.3	-	-	0.1-0.21	0.1-0.21	0.1-0.26	-
								40.01-52.00	-	0.12-0.25	0.12-0.25	0.12-0.3	-	-	0.12-0.21	0.12-0.21	0.12-0.26	-
					52.01-65.00	-	0.12-0.25	0.12-0.25	0.12-0.3	-	-	0.12-0.21	0.12-0.21	0.12-0.26	-			
	K3.1.C.UT	Nodular cast iron Ferritic	155	4324	125	190	225	15.00-18.00	-	0.08-0.13	0.08-0.13	0.08-0.18	-	-	0.08-0.11	0.08-0.11	0.08-0.15	-
				4334	100	155	185	18.01-22.00	-	0.08-0.16	0.08-0.16	0.08-0.21	-	-	0.08-0.14	0.08-0.14	0.08-0.18	-
				4344	80	120	145	22.01-27.00	-	0.08-0.19	0.08-0.19	0.08-0.24	-	-	0.08-0.16	0.08-0.16	0.08-0.2	-
							27.01-33.00	-	0.1-0.22	0.1-0.22	0.1-0.27	-	-	0.1-0.19	0.1-0.19	0.1-0.23	-	
							33.01-40.00	-	0.1-0.25	0.1-0.25	0.1-0.3	-	-	0.1-0.21	0.1-0.21	0.1-0.26	-	
							40.01-52.00	-	0.12-0.25	0.12-0.25	0.12-0.3	-	-	0.12-0.21	0.12-0.21	0.12-0.26	-	
				52.01-65.00	-	0.12-0.25	0.12-0.25	0.12-0.3	-	-	0.12-0.21	0.12-0.21	0.12-0.26	-				
K3.3.C.UT	Nodular cast iron Pearlitic	265	4324	110	175	210	15.00-18.00	-	0.08-0.13	0.08-0.13	0.08-0.18	-	-	0.08-0.11	0.08-0.11	0.08-0.15	-	
			4334	90	145	175	18.01-22.00	-	0.08-0.16	0.08-0.16	0.08-0.21	-	-	0.08-0.14	0.08-0.14	0.08-0.18	-	
			4344	70	110	130	22.01-27.00	-	0.08-0.19	0.08-0.19	0.08-0.24	-	-	0.08-0.16	0.08-0.16	0.08-0.2	-	
							27.01-33.00	-	0.1-0.22	0.1-0.22	0.1-0.27	-	-	0.1-0.19	0.1-0.19	0.1-0.23	-	
							33.01-40.00	-	0.1-0.25	0.1-0.25	0.1-0.3	-	-	0.1-0.21	0.1-0.21	0.1-0.26	-	
							40.01-52.00	-	0.12-0.25	0.12-0.25	0.12-0.3	-	-	0.12-0.21	0.12-0.21	0.12-0.26	-	
				52.01-65.00	-	0.12-0.25	0.12-0.25	0.12-0.3	-	-	0.12-0.21	0.12-0.21	0.12-0.26	-				
K4.2.C.UT	Compacted graphite iron High tensile strength (Pearlite>90%)	230	4324	130	210	250	15.00-18.00	-	0.08-0.13	0.08-0.13	0.08-0.18	-	-	0.08-0.11	0.08-0.11	0.08-0.15	-	
			4334	110	170	200	18.01-22.00	-	0.08-0.16	0.08-0.16	0.08-0.21	-	-	0.08-0.14	0.08-0.14	0.08-0.18	-	
			4344	85	125	150	22.01-27.00	-	0.08-0.19	0.08-0.19	0.08-0.24	-	-	0.08-0.16	0.08-0.16	0.08-0.2	-	
							27.01-33.00	-	0.1-0.22	0.1-0.22	0.1-0.27	-	-	0.1-0.19	0.1-0.19	0.1-0.23	-	
							33.01-40.00	-	0.1-0.25	0.1-0.25	0.1-0.3	-	-	0.1-0.21	0.1-0.21	0.1-0.26	-	
							40.01-52.00	-	0.12-0.25	0.12-0.25	0.12-0.3	-	-	0.12-0.21	0.12-0.21	0.12-0.26	-	
				52.01-65.00	-	0.12-0.25	0.12-0.25	0.12-0.3	-	-	0.12-0.21	0.12-0.21	0.12-0.26	-				
H	H1.3.Z.HA	Extra hard steels Hardened and tempered	60 (HRC)	4324	30	65	85	15.00-18.00	-	0.06-0.13	0.06-0.13	0.06-0.13	-	-	0.06-0.11	0.06-0.11	0.06-0.11	-
				4334	30	65	85	18.01-22.00	-	0.06-0.14	0.06-0.14	0.06-0.14	-	-	0.06-0.12	0.06-0.12	0.06-0.12	-
				4344	30	65	85	22.01-27.00	-	0.06-0.15	0.06-0.15	0.06-0.15	-	-	0.06-0.13	0.06-0.13	0.06-0.13	-
								27.01-33.00	-	0.08-0.16	0.08-0.16	0.08-0.16	-	-	0.08-0.14	0.08-0.14	0.08-0.14	-
								33.01-40.00	-	0.08-0.18	0.08-0.18	0.08-0.18	-	-	0.08-0.15	0.08-0.15	0.08-0.15	-
								40.01-52.00	-	0.1-0.18	0.1-0.18	0.1-0.18	-	-	0.1-0.15	0.1-0.15	0.1-0.15	-
				52.01-65.00	-	0.1-0.18	0.1-0.18	0.1-0.18	-	-	0.1-0.15	0.1-0.15	0.1-0.15	-				

CoroDrill® DS20

4-5xD

Metric values

ISO	MC No.	Material	HB	Grade	Cutting speed recommendations			Drill diameter	Drill length 4xD					Drill length 5xD				
									-S5W	-L5W	-L6W	-M7W	-H5W	-S5W	-L5W	-L6W	-M7W	-H5W
N	N1.2.Z.AG	Aluminium based alloys AlSi alloys, Si ≤ 1%	100	H13A 4344	300	365	400	15.00-18.00	0.06-0.16	0.06-0.16	0.06-0.16	-	-	0.06-0.14	0.06-0.14	0.06-0.14	-	-
								18.01-22.00	0.06-0.18	0.06-0.18	0.06-0.18	-	-	0.06-0.15	0.06-0.15	0.06-0.15	-	-
								22.01-27.00	0.06-0.2	0.06-0.2	0.06-0.2	-	-	0.06-0.17	0.06-0.17	0.06-0.17	-	-
					27.01-33.00	0.08-0.22	0.08-0.22	0.08-0.22	0.08-0.22	0.08-0.22	-	-	0.08-0.19	0.08-0.19	0.08-0.19	-	-	
					33.01-40.00	0.08-0.25	0.08-0.25	0.08-0.25	-	-	0.08-0.21	0.08-0.21	0.08-0.21	-	-			
					40.01-52.00	0.1-0.25	0.1-0.25	0.1-0.25	-	-	0.1-0.21	0.1-0.21	0.1-0.21	-	-			
					52.01-65.00	0.1-0.25	0.1-0.25	0.1-0.25	-	-	0.1-0.21	0.1-0.21	0.1-0.21	-	-			
	N1.3.C.UT	Aluminium based alloys AlSi cast alloys (1% < Si < 13%)	75	H13A 4344	250	350	400	15.00-18.00	0.06-0.14	0.06-0.14	0.06-0.14	-	-	0.06-0.12	0.06-0.12	0.06-0.12	-	-
								18.01-22.00	0.06-0.16	0.06-0.16	0.06-0.16	-	-	0.06-0.14	0.06-0.14	0.06-0.14	-	-
								22.01-27.00	0.06-0.18	0.06-0.18	0.06-0.18	-	-	0.06-0.15	0.06-0.15	0.06-0.15	-	-
					27.01-33.00	0.08-0.2	0.08-0.2	0.08-0.2	0.08-0.2	0.08-0.2	-	-	0.08-0.17	0.08-0.17	0.08-0.17	-	-	
					33.01-40.00	0.08-0.22	0.08-0.22	0.08-0.22	-	-	0.08-0.19	0.08-0.19	0.08-0.19	-	-			
					40.01-52.00	0.1-0.22	0.1-0.22	0.1-0.22	-	-	0.1-0.19	0.1-0.19	0.1-0.19	-	-			
					52.01-65.00	0.1-0.22	0.1-0.22	0.1-0.22	-	-	0.1-0.19	0.1-0.19	0.1-0.19	-	-			
	N1.3.C.AG	Aluminium based alloys AlSi cast and aged alloys (1% < Si < 13%)	90	H13A 4344	250	315	350	15.00-18.00	0.06-0.14	0.06-0.14	0.06-0.14	-	-	0.06-0.12	0.06-0.12	0.06-0.12	-	-
								18.01-22.00	0.06-0.16	0.06-0.16	0.06-0.16	-	-	0.06-0.14	0.06-0.14	0.06-0.14	-	-
								22.01-27.00	0.06-0.18	0.06-0.18	0.06-0.18	-	-	0.06-0.15	0.06-0.15	0.06-0.15	-	-
					27.01-33.00	0.08-0.2	0.08-0.2	0.08-0.2	0.08-0.2	0.08-0.2	-	-	0.08-0.17	0.08-0.17	0.08-0.17	-	-	
					33.01-40.00	0.08-0.22	0.08-0.22	0.08-0.22	0.08-0.22	0.08-0.22	-	-	0.08-0.19	0.08-0.19	0.08-0.19	-	-	
					40.01-52.00	0.1-0.22	0.1-0.22	0.1-0.22	-	-	0.1-0.19	0.1-0.19	0.1-0.19	-	-			
					52.01-65.00	0.1-0.22	0.1-0.22	0.1-0.22	-	-	0.1-0.19	0.1-0.19	0.1-0.19	-	-			
	N3.3.U.UT	Copper based alloys Free cutting copper based alloys	110	H13A 4344	250	350	400	15.00-18.00	0.06-0.16	0.06-0.16	0.06-0.16	-	-	0.06-0.14	0.06-0.14	0.06-0.14	-	-
								18.01-22.00	0.06-0.18	0.06-0.18	0.06-0.18	-	-	0.06-0.15	0.06-0.15	0.06-0.15	-	-
								22.01-27.00	0.06-0.2	0.06-0.2	0.06-0.2	-	-	0.06-0.17	0.06-0.17	0.06-0.17	-	-
27.01-33.00					0.08-0.22	0.08-0.22	0.08-0.22	0.08-0.22	0.08-0.22	-	-	0.08-0.19	0.08-0.19	0.08-0.19	-	-		
33.01-40.00					0.08-0.25	0.08-0.25	0.08-0.25	0.08-0.25	0.08-0.25	-	-	0.08-0.21	0.08-0.21	0.08-0.21	-	-		
40.01-52.00					0.1-0.25	0.1-0.25	0.1-0.25	-	-	0.1-0.21	0.1-0.21	0.1-0.21	-	-				
52.01-65.00					0.1-0.25	0.1-0.25	0.1-0.25	-	-	0.1-0.21	0.1-0.21	0.1-0.21	-	-				
N3.2.C.UT	Copper based alloys Leaded brass and bronzes (Pb<1%)	90	H13A 4344	180	220	240	15.00-18.00	0.06-0.16	0.06-0.16	0.06-0.16	-	-	0.06-0.14	0.06-0.14	0.06-0.14	-	-	
							18.01-22.00	0.06-0.18	0.06-0.18	0.06-0.18	-	-	0.06-0.15	0.06-0.15	0.06-0.15	-	-	
							22.01-27.00	0.06-0.2	0.06-0.2	0.06-0.2	-	-	0.06-0.17	0.06-0.17	0.06-0.17	-	-	
				27.01-33.00	0.08-0.22	0.08-0.22	0.08-0.22	0.08-0.22	0.08-0.22	-	-	0.08-0.19	0.08-0.19	0.08-0.19	-	-		
				33.01-40.00	0.08-0.25	0.08-0.25	0.08-0.25	0.08-0.25	0.08-0.25	-	-	0.08-0.21	0.08-0.21	0.08-0.21	-	-		
				40.01-52.00	0.1-0.25	0.1-0.25	0.1-0.25	-	-	0.1-0.21	0.1-0.21	0.1-0.21	-	-				
				52.01-65.00	0.1-0.25	0.1-0.25	0.1-0.25	-	-	0.1-0.21	0.1-0.21	0.1-0.21	-	-				

CoroDrill® DS20

6-7xD

Metric values

ISO	MC No.	Material	HB	Grade	Cutting speed recommendations			Drill diameter	Drill length 6xD					Drill length 7xD					
					Min.	Rec.	Max.		-S5W	-L5W	-L6W	-M7W	-H5W	-S5W	-L5W	-L6W	-M7W	-H5W	
																			Recommended start value at middle of feed range
								f_c mm/rev	f_c mm/rev	f_c mm/rev	f_c mm/rev	f_c mm/rev	f_c mm/rev	f_c mm/rev	f_c mm/rev	f_c mm/rev	f_c mm/rev	f_c mm/rev	f_c mm/rev
P	P1.0.ZAN	Unalloyed steel C=0.05-0.10%	110	4324	230	305	360	15.00-18.00	0.04-0.06	0.04-0.06	0.04-0.06	-	0.04-0.08	0.04-0.05	0.04-0.05	0.04-0.05	-	0.04-0.07	
				4334	210	255	295	18.01-22.00	0.04-0.07	0.04-0.07	0.04-0.07	-	0.04-0.09	0.04-0.06	0.04-0.06	0.04-0.06	-	0.04-0.07	
				4344	190	205	220	22.01-27.00	0.04-0.08	0.04-0.08	0.04-0.08	-	0.04-0.1	0.04-0.07	0.04-0.07	0.04-0.07	-	0.04-0.08	
							27.01-33.00	0.05-0.09	0.05-0.09	0.05-0.09	-	0.05-0.1	0.05-0.07	0.05-0.07	0.05-0.07	-	0.05-0.08		
							33.01-40.00	0.05-0.1	0.05-0.1	0.05-0.1	-	0.05-0.13	0.05-0.08	0.05-0.08	0.05-0.08	-	0.05-0.1		
							40.01-52.00	0.06-0.1	0.06-0.1	0.06-0.1	-	0.06-0.13	0.06-0.08	0.06-0.08	0.06-0.08	-	0.06-0.1		
							52.01-65.00	0.06-0.1	0.06-0.1	0.06-0.1	-	0.06-0.13	0.06-0.08	0.06-0.08	0.06-0.08	-	0.06-0.1		
		P1.1.ZAN	Unalloyed steel C=0.05-0.25%	125	4324	230	290	335	15.00-18.00	0.04-0.08	0.04-0.08	0.04-0.08	-	0.04-0.08	0.04-0.07	0.04-0.07	0.04-0.07	-	0.04-0.07
	4334				200	245	275	18.01-22.00	0.04-0.09	0.04-0.09	0.04-0.09	-	0.04-0.09	0.04-0.07	0.04-0.07	0.04-0.07	-	0.04-0.07	
	4344				170	190	210	22.01-27.00	0.04-0.1	0.04-0.1	0.04-0.1	-	0.04-0.1	0.04-0.08	0.04-0.08	0.04-0.08	-	0.04-0.08	
							27.01-33.00	0.05-0.1	0.05-0.1	0.05-0.1	-	0.05-0.1	0.05-0.08	0.05-0.08	0.05-0.08	-	0.05-0.08		
							33.01-40.00	0.05-0.11	0.05-0.11	0.05-0.11	-	0.05-0.13	0.05-0.09	0.05-0.09	0.05-0.09	-	0.05-0.1		
							40.01-52.00	0.06-0.11	0.06-0.11	0.06-0.11	-	0.06-0.13	0.06-0.09	0.06-0.09	0.06-0.09	-	0.06-0.1		
							52.01-65.00	0.06-0.11	0.06-0.11	0.06-0.11	-	0.06-0.13	0.06-0.09	0.06-0.09	0.06-0.09	-	0.06-0.1		
		P1.2.ZAN	Unalloyed steel C=0.25-0.55%	190	4324	190	240	275	15.00-18.00	-	0.05-0.08	0.06-0.09	0.06-0.1	-	-	0.05-0.07	0.06-0.08	0.06-0.09	-
	4334				155	195	225	18.01-22.00	-	0.05-0.09	0.06-0.1	0.06-0.12	-	-	0.05-0.08	0.06-0.09	0.06-0.1	-	
	4344				120	150	170	22.01-27.00	-	0.05-0.12	0.06-0.13	0.06-0.14	-	-	0.05-0.1	0.06-0.11	0.06-0.12	-	
							27.01-33.00	-	0.07-0.14	0.08-0.16	0.08-0.17	-	-	0.07-0.12	0.08-0.13	0.08-0.14	-		
							33.01-40.00	-	0.07-0.16	0.08-0.17	0.08-0.18	-	-	0.07-0.13	0.08-0.14	0.08-0.15	-		
							40.01-52.00	-	0.09-0.16	0.1-0.17	0.1-0.18	-	-	0.09-0.13	0.1-0.14	0.1-0.15	-		
							52.01-65.00	-	0.09-0.16	0.1-0.17	0.1-0.18	-	-	0.09-0.13	0.1-0.14	0.1-0.15	-		
		P1.3.ZAN	Unalloyed steel C=0.55-0.80%	190	4324	170	225	260	15.00-18.00	-	0.05-0.08	0.06-0.09	0.06-0.1	-	-	0.05-0.07	0.06-0.08	0.06-0.09	-
	4334				140	185	215	18.01-22.00	-	0.05-0.09	0.06-0.1	0.06-0.12	-	-	0.05-0.08	0.06-0.09	0.06-0.1	-	
	4344				105	140	165	22.01-27.00	-	0.05-0.12	0.06-0.13	0.06-0.14	-	-	0.05-0.1	0.06-0.11	0.06-0.12	-	
							27.01-33.00	-	0.07-0.14	0.08-0.16	0.08-0.17	-	-	0.07-0.12	0.08-0.13	0.08-0.14	-		
							33.01-40.00	-	0.07-0.16	0.08-0.17	0.08-0.18	-	-	0.07-0.13	0.08-0.14	0.08-0.15	-		
							40.01-52.00	-	0.09-0.16	0.1-0.17	0.1-0.18	-	-	0.09-0.13	0.1-0.14	0.1-0.15	-		
							52.01-65.00	-	0.09-0.16	0.1-0.17	0.1-0.18	-	-	0.09-0.13	0.1-0.14	0.1-0.15	-		
	P1.5.CUT	Unalloyed steel Cast - untreated	150	4324	140	235	295	15.00-18.00	-	0.04-0.08	0.04-0.08	0.04-0.08	-	-	0.04-0.07	0.04-0.07	0.04-0.07	-	
4334				135	200	240	18.01-22.00	-	0.04-0.08	0.04-0.08	0.04-0.08	-	-	0.04-0.07	0.04-0.07	0.04-0.07	-		
4344				125	160	180	22.01-27.00	-	0.04-0.09	0.04-0.09	0.04-0.09	-	-	0.04-0.08	0.04-0.08	0.04-0.08	-		
						27.01-33.00	-	0.05-0.1	0.05-0.1	0.05-0.1	-	-	0.05-0.08	0.05-0.08	0.05-0.08	-			
						33.01-40.00	-	0.05-0.1	0.05-0.1	0.05-0.1	-	-	0.05-0.09	0.05-0.09	0.05-0.09	-			
						40.01-52.00	-	0.06-0.1	0.06-0.1	0.06-0.1	-	-	0.06-0.09	0.06-0.09	0.06-0.09	-			
						52.01-65.00	-	0.06-0.1	0.06-0.1	0.06-0.1	-	-	0.06-0.09	0.06-0.09	0.06-0.09	-			
	P2.1.ZAN	Low alloy steel Annealed	175	4324	180	235	275	15.00-18.00	-	-	0.06-0.09	0.06-0.1	-	-	-	0.06-0.08	0.06-0.09	-	
4334				150	195	225	18.01-22.00	-	-	0.06-0.1	0.06-0.12	-	-	-	0.06-0.09	0.06-0.1	-		
4344				115	150	170	22.01-27.00	-	-	0.06-0.13	0.06-0.14	-	-	-	0.06-0.11	0.06-0.12	-		
						27.01-33.00	-	-	0.08-0.16	0.08-0.17	-	-	-	0.08-0.13	0.08-0.14	-			
						33.01-40.00	-	-	0.08-0.17	0.08-0.18	-	-	-	0.08-0.14	0.08-0.15	-			
						40.01-52.00	-	-	0.1-0.17	0.1-0.18	-	-	-	0.1-0.14	0.1-0.15	-			
						52.01-65.00	-	-	0.1-0.17	0.1-0.18	-	-	-	0.1-0.14	0.1-0.15	-			
	P2.2.ZAN	Low alloy steel Annealed	240	4324	180	225	260	15.00-18.00	-	-	0.06-0.09	0.06-0.1	-	-	-	0.06-0.08	0.06-0.09	-	
4334				150	180	205	18.01-22.00	-	-	0.06-0.1	0.06-0.12	-	-	-	0.06-0.09	0.06-0.1	-		
4344				115	160	185	22.01-27.00	-	-	0.06-0.13	0.06-0.14	-	-	-	0.06-0.11	0.06-0.12	-		
						27.01-33.00	-	-	0.08-0.16	0.08-0.17	-	-	-	0.08-0.13	0.08-0.14	-			
						33.01-40.00	-	-	0.08-0.17	0.08-0.18	-	-	-	0.08-0.14	0.08-0.15	-			
						40.01-52.00	-	-	0.1-0.17	0.1-0.18	-	-	-	0.1-0.14	0.1-0.15	-			
						52.01-65.00	-	-	0.1-0.17	0.1-0.18	-	-	-	0.1-0.14	0.1-0.15	-			
	P2.5.ZHT	Low alloy steel Hardened and tempered	330	4324	90	170	220	15.00-18.00	-	-	0.06-0.09	0.06-0.1	-	-	-	0.06-0.08	0.06-0.09	-	
4334				85	140	175	18.01-22.00	-	-	0.06-0.1	0.06-0.12	-	-	-	0.06-0.09	0.06-0.1	-		
4344				75	115	135	22.01-27.00	-	-	0.06-0.13	0.06-0.14	-	-	-	0.06-0.11	0.06-0.12	-		
						27.01-33.00	-	-	0.08-0.16	0.08-0.17	-	-	-	0.08-0.13	0.08-0.14	-			
						33.01-40.00	-	-	0.08-0.17	0.08-0.18	-	-	-	0.08-0.14	0.08-0.15	-			
						40.01-52.00	-	-	0.1-0.17	0.1-0.18	-	-	-	0.1-0.14	0.1-0.15	-			
						52.01-65.00	-	-	0.1-0.17	0.1-0.18	-	-	-	0.1-0.14	0.1-0.15	-			
	P2.6.CUT	Low alloy steel Cast - untreated	200	4324	110	190	240	15.00-18.00	-	-	0.06-0.1	0.06-0.12	-	-	-	0.06-0.09	0.06-0.1	-	
4334				105	160	190	18.01-22.00	-	-	0.06-0.12	0.06-0.13	-	-	-	0.06-0.1	0.06-0.11	-		
4344				100	125	145	22.01-27.00	-	-	0.06-0.14	0.06-0.16	-	-	-	0.06-0.12	0.06-0.13	-		
						27.01-33.00	-	-	0.08-0.17	0.08-0.18	-	-	-	0.08-0.14	0.08-0.15	-			
						33.01-40.00	-	-	0.08-0.18	0.08-0.2	-	-	-	0.08-0.15	0.08-0.17	-			
						40.01-52.00	-	-	0.1-0.18	0.1-0.2	-	-	-	0.1-0.15	0.1-0.17	-			
						52.01-65.00	-	-	0.1-0.18	0.1-0.2	-	-	-	0.1-0.15	0.1-0.17	-			
	P3.0.ZAN	High alloy steel Annealed	200	4324	160	220	260	15.00-18.00	-	-	0.06-0.09	0.06-0.1	-	-	-	0.06-0.08	0.06-0.09	-	
4334				130	180	215	18.01-22.00	-	-	0.06-0.1	0.06-0.12	-	-	-	0.06-0.09	0.06-0.1	-		
4344				100	135	160	22.01-27.00	-	-	0.06-0.13	0.06-0.14	-	-	-	0.06-0.11	0.06-0.12	-		
						27.01-33.00	-	-	0.08-0.16	0.08-0.17	-	-							

CoroDrill® DS20

6-7xD

Metric values

ISO	MC No.	Material	HB	Grade	Cutting speed recommendations			Drill diameter	Drill length 6xD					Drill length 7xD				
					6-7xD	-S5W	-L5W		-L6W	-M7W	-H5W	-S5W	-L5W	-L6W	-M7W	-H5W		
						Recommended start value at middle of feed range												
P	P3.0.Z.HT	High alloy steel	380	4324	80	150	190	15.00-18.00	-	-	0.06-0.09	0.06-0.1	-	-	-	0.06-0.08	0.06-0.09	-
				4334	75	125	160	18.01-22.00	-	-	0.06-0.1	0.06-0.12	-	-	-	0.06-0.09	0.06-0.1	-
				4344	70	100	115	22.01-27.00	-	-	0.06-0.13	0.06-0.14	-	-	-	0.06-0.11	0.06-0.12	-
		Hardened and tempered	27.01-33.00	-	-	0.08-0.16	0.08-0.17	-	-	-	-	0.08-0.13	0.08-0.14	-				
			33.01-40.00	-	-	0.08-0.17	0.08-0.18	-	-	-	-	0.08-0.14	0.08-0.15	-				
			40.01-52.00	-	-	0.1-0.17	0.1-0.18	-	-	-	-	0.1-0.14	0.1-0.15	-				
	52.01-65.00	-	-	0.1-0.17	0.1-0.18	-	-	-	-	0.1-0.14	0.1-0.15	-						
	P5.0.Z.AN	Ferritic/martensitic stainless steel Annealed	200	4334	115	165	205	15.00-18.00	0.05-0.08	0.05-0.08	0.05-0.08	-	0.05-0.08	0.05-0.07	0.05-0.07	0.05-0.07	-	0.05-0.07
				4344	115	140	160	18.01-22.00	0.05-0.09	0.05-0.09	0.05-0.09	-	0.05-0.08	0.05-0.08	0.05-0.08	0.05-0.08	-	0.05-0.07
				2044	115	135	150	22.01-27.00	0.05-0.1	0.05-0.1	0.05-0.1	-	0.05-0.09	0.05-0.08	0.05-0.08	0.05-0.08	-	0.05-0.08
				27.01-33.00	0.07-0.1	0.07-0.1	0.07-0.1	-	0.07-0.1	0.07-0.09	0.07-0.09	0.07-0.09	-	0.07-0.1	0.07-0.09	-	0.07-0.08	
				33.01-40.00	0.07-0.12	0.07-0.12	0.07-0.12	-	0.07-0.1	0.07-0.1	0.07-0.1	0.07-0.1	-	0.07-0.1	0.07-0.1	-	0.07-0.09	
40.01-52.00				0.09-0.12	0.09-0.12	0.09-0.12	-	0.09-0.1	0.09-0.1	0.09-0.1	0.09-0.1	-	0.09-0.1	0.09-0.1	-	0.09-0.09		
52.01-65.00	0.09-0.12	0.09-0.12	0.09-0.12	-	0.09-0.1	0.09-0.1	0.09-0.1	0.09-0.1	-	0.09-0.1	0.09-0.1	-	0.09-0.09					
P5.0.Z.HT	Ferritic/martensitic stainless steel Hardened and tempered	330	4334	75	120	155	15.00-18.00	0.05-0.08	0.05-0.08	0.05-0.08	-	0.05-0.08	0.05-0.07	0.05-0.07	0.05-0.07	-	0.05-0.07	
			4344	70	105	125	18.01-22.00	0.05-0.09	0.05-0.09	0.05-0.09	-	0.05-0.08	0.05-0.08	0.05-0.08	0.05-0.08	-	0.05-0.07	
			2044	70	105	125	22.01-27.00	0.05-0.1	0.05-0.1	0.05-0.1	-	0.05-0.09	0.05-0.08	0.05-0.08	0.05-0.08	-	0.05-0.08	
			27.01-33.00	0.07-0.1	0.07-0.1	0.07-0.1	-	0.07-0.1	0.07-0.09	0.07-0.09	0.07-0.09	-	0.07-0.1	0.07-0.09	-	0.07-0.08		
			33.01-40.00	0.07-0.12	0.07-0.12	0.07-0.12	-	0.07-0.1	0.07-0.1	0.07-0.1	0.07-0.1	-	0.07-0.1	0.07-0.1	-	0.07-0.09		
			40.01-52.00	0.09-0.12	0.09-0.12	0.09-0.12	-	0.09-0.1	0.09-0.1	0.09-0.1	0.09-0.1	-	0.09-0.1	0.09-0.1	-	0.09-0.09		
52.01-65.00	0.09-0.12	0.09-0.12	0.09-0.12	-	0.09-0.1	0.09-0.1	0.09-0.1	0.09-0.1	-	0.09-0.1	0.09-0.1	-	0.09-0.09					
M	M1.0.Z.AQ	Austenitic stainless steel Annealed/quenched	200	4334	115	165	205	15.00-18.00	0.05-0.1	0.05-0.1	0.05-0.1	-	0.05-0.09	0.05-0.08	0.05-0.08	0.05-0.08	-	0.05-0.07
				4344	115	150	170	18.01-22.00	0.05-0.1	0.05-0.1	0.05-0.1	-	0.05-0.1	0.05-0.08	0.05-0.08	0.05-0.08	-	0.05-0.08
				2044	115	140	160	22.01-27.00	0.05-0.11	0.05-0.11	0.05-0.11	-	0.05-0.1	0.05-0.09	0.05-0.09	0.05-0.09	-	0.05-0.08
				27.01-33.00	0.07-0.12	0.07-0.12	0.07-0.12	-	0.07-0.11	0.07-0.1	0.07-0.1	0.07-0.1	-	0.07-0.1	0.07-0.1	-	0.07-0.09	
				33.01-40.00	0.07-0.13	0.07-0.13	0.07-0.13	-	0.07-0.12	0.07-0.1	0.07-0.1	0.07-0.1	-	0.07-0.1	0.07-0.1	-	0.07-0.1	
				40.01-52.00	0.09-0.13	0.09-0.13	0.09-0.13	-	0.09-0.12	0.09-0.1	0.09-0.1	0.09-0.1	-	0.09-0.1	0.09-0.1	-	0.09-0.1	
	52.01-65.00	0.09-0.13	0.09-0.13	0.09-0.13	-	0.09-0.12	0.09-0.1	0.09-0.1	0.09-0.1	-	0.09-0.1	0.09-0.1	-	0.09-0.1				
	M1.1.Z.AQ	Austenitic stainless steel Machinability improved	200	4334	115	175	215	15.00-18.00	0.05-0.1	0.05-0.1	0.05-0.1	-	0.05-0.09	0.05-0.08	0.05-0.08	0.05-0.08	-	0.05-0.07
				4344	115	160	190	18.01-22.00	0.05-0.1	0.05-0.1	0.05-0.1	-	0.05-0.1	0.05-0.08	0.05-0.08	0.05-0.08	-	0.05-0.08
				2044	115	155	180	22.01-27.00	0.05-0.11	0.05-0.11	0.05-0.11	-	0.05-0.1	0.05-0.09	0.05-0.09	0.05-0.09	-	0.05-0.08
				27.01-33.00	0.07-0.12	0.07-0.12	0.07-0.12	-	0.07-0.11	0.07-0.1	0.07-0.1	0.07-0.1	-	0.07-0.1	0.07-0.1	-	0.07-0.09	
				33.01-40.00	0.07-0.13	0.07-0.13	0.07-0.13	-	0.07-0.12	0.07-0.1	0.07-0.1	0.07-0.1	-	0.07-0.1	0.07-0.1	-	0.07-0.1	
				40.01-52.00	0.09-0.13	0.09-0.13	0.09-0.13	-	0.09-0.12	0.09-0.1	0.09-0.1	0.09-0.1	-	0.09-0.1	0.09-0.1	-	0.09-0.1	
	52.01-65.00	0.09-0.13	0.09-0.13	0.09-0.13	-	0.09-0.12	0.09-0.1	0.09-0.1	0.09-0.1	-	0.09-0.1	0.09-0.1	-	0.09-0.1				
	M2.0.Z.AQ	Super austenitic (N>20%) stainless steel Annealed/quenched	200	4334	80	115	135	15.00-18.00	0.05-0.1	0.05-0.1	0.05-0.1	-	0.05-0.09	0.05-0.08	0.05-0.08	0.05-0.08	-	0.05-0.07
				4344	80	100	115	18.01-22.00	0.05-0.1	0.05-0.1	0.05-0.1	-	0.05-0.1	0.05-0.08	0.05-0.08	0.05-0.08	-	0.05-0.08
				2044	80	100	115	22.01-27.00	0.05-0.11	0.05-0.11	0.05-0.11	-	0.05-0.1	0.05-0.09	0.05-0.09	0.05-0.09	-	0.05-0.08
				27.01-33.00	0.07-0.12	0.07-0.12	0.07-0.12	-	0.07-0.11	0.07-0.1	0.07-0.1	0.07-0.1	-	0.07-0.1	0.07-0.1	-	0.07-0.09	
				33.01-40.00	0.07-0.13	0.07-0.13	0.07-0.13	-	0.07-0.12	0.07-0.1	0.07-0.1	0.07-0.1	-	0.07-0.1	0.07-0.1	-	0.07-0.1	
				40.01-52.00	0.09-0.13	0.09-0.13	0.09-0.13	-	0.09-0.12	0.09-0.1	0.09-0.1	0.09-0.1	-	0.09-0.1	0.09-0.1	-	0.09-0.1	
	52.01-65.00	0.09-0.13	0.09-0.13	0.09-0.13	-	0.09-0.12	0.09-0.1	0.09-0.1	0.09-0.1	-	0.09-0.1	0.09-0.1	-	0.09-0.1				
	M3.1.Z.AQ	Duplex stainless steel >60% ferrite (N<0.10%)	230	4334	85	115	130	15.00-18.00	0.05-0.1	0.05-0.1	0.05-0.1	-	0.05-0.09	0.05-0.08	0.05-0.08	0.05-0.08	-	0.05-0.07
				4344	85	105	115	18.01-22.00	0.05-0.1	0.05-0.1	0.05-0.1	-	0.05-0.1	0.05-0.08	0.05-0.08	0.05-0.08	-	0.05-0.08
				2044	85	100	115	22.01-27.00	0.05-0.11	0.05-0.11	0.05-0.11	-	0.05-0.1	0.05-0.09	0.05-0.09	0.05-0.09	-	0.05-0.08
27.01-33.00				0.07-0.12	0.07-0.12	0.07-0.12	-	0.07-0.11	0.07-0.1	0.07-0.1	0.07-0.1	-	0.07-0.1	0.07-0.1	-	0.07-0.09		
33.01-40.00				0.07-0.13	0.07-0.13	0.07-0.13	-	0.07-0.12	0.07-0.1	0.07-0.1	0.07-0.1	-	0.07-0.1	0.07-0.1	-	0.07-0.1		
40.01-52.00				0.09-0.13	0.09-0.13	0.09-0.13	-	0.09-0.12	0.09-0.1	0.09-0.1	0.09-0.1	-	0.09-0.1	0.09-0.1	-	0.09-0.1		
52.01-65.00	0.09-0.13	0.09-0.13	0.09-0.13	-	0.09-0.12	0.09-0.1	0.09-0.1	0.09-0.1	-	0.09-0.1	0.09-0.1	-	0.09-0.1					
M3.2.Z.AQ	Duplex stainless steel <60% ferrite (N>0.10%)	260	4334	75	95	110	15.00-18.00	0.05-0.1	0.05-0.1	0.05-0.1	-	0.05-0.09	0.05-0.08	0.05-0.08	0.05-0.08	-	0.05-0.07	
			4344	75	90	105	18.01-22.00	0.05-0.1	0.05-0.1	0.05-0.1	-	0.05-0.1	0.05-0.08	0.05-0.08	0.05-0.08	-	0.05-0.08	
			2044	75	90	105	22.01-27.00	0.05-0.11	0.05-0.11	0.05-0.11	-	0.05-0.1	0.05-0.09	0.05-0.09	0.05-0.09	-	0.05-0.08	
			27.01-33.00	0.07-0.12	0.07-0.12	0.07-0.12	-	0.07-0.11	0.07-0.1	0.07-0.1	0.07-0.1	-	0.07-0.1	0.07-0.1	-	0.07-0.09		
			33.01-40.00	0.07-0.13	0.07-0.13	0.07-0.13	-	0.07-0.12	0.07-0.1	0.07-0.1	0.07-0.1	-	0.07-0.1	0.07-0.1	-	0.07-0.1		
			40.01-52.00	0.09-0.13	0.09-0.13	0.09-0.13	-	0.09-0.12	0.09-0.1	0.09-0.1	0.09-0.1	-	0.09-0.1	0.09-0.1	-	0.09-0.1		
52.01-65.00	0.09-0.13	0.09-0.13	0.09-0.13	-	0.09-0.12	0.09-0.1	0.09-0.1	0.09-0.1	-	0.09-0.1	0.09-0.1	-	0.09-0.1					
S	S2.0.Z.AN S2.0.Z.AG S2.0.Z.NS	Heat resistant super alloys Ni based	350	4334	20	35	45	15.00-18.00	0.04-0.06	0.04-0.06	0.04-0.06	-	-	0.04-0.05	0.04-0.05	0.04-0.05	-	
				4344	20	35	45	18.01-22.00	0.04-0.07	0.04-0.07	0.04-0.07	-	-	0.04-0.06	0.04-0.06	0.04-0.06	-	
				2044	20	35	45	22.01-27.00	0.04-0.08	0.04-0.08	0.04-0.08	-	-	0.04-0.07	0.04-0.07	0.04-0.07	-	
				27.01-33.00	0.05-0.09	0.05-0.09	0.05-0.09	-	-	0.05-0.07	0.05-0.07	0.05-0.07	-	-	0.05-0.07	0.05-0.07	-	
				33.01-40.00	0.05-0.1	0.05-0.1	0.05-0.1	-	-	0.05								

CoroDrill® DS20

6-7xD

Metric values

ISO	MC No.	Material	HB	Grade	Cutting speed recommendations			Drill diameter	Drill length 6xD					Drill length 7xD				
					6-7xD	-S5W	-L5W		-L6W	-M7W	-H5W	-S5W	-L5W	-L6W	-M7W	-H5W		
K	K1.1.C.NS	Malleable cast iron Low tensile strength	200	4324	140	190	220	15.00-18.00	-	0.08-0.1	0.08-0.1	0.08-0.13	-	-	0.08-0.08	0.08-0.08	0.08-0.11	-
				4334	110	155	180	18.01-22.00	-	0.08-0.12	0.08-0.12	0.08-0.15	-	-	0.08-0.1	0.08-0.1	0.08-0.13	-
				4344	180	150	140	22.01-27.00	-	0.08-0.14	0.08-0.14	0.08-0.17	-	-	0.08-0.12	0.08-0.12	0.08-0.14	-
								27.01-33.00	-	0.1-0.16	0.1-0.16	0.1-0.19	-	-	0.1-0.13	0.1-0.13	0.1-0.16	-
								33.01-40.00	-	0.1-0.18	0.1-0.18	0.1-0.21	-	-	0.1-0.15	0.1-0.15	0.1-0.18	-
								40.01-52.00	-	0.12-0.18	0.12-0.18	0.12-0.21	-	-	0.12-0.15	0.12-0.15	0.12-0.18	-
					52.01-65.00	-	0.12-0.18	0.12-0.18	0.12-0.21	-	-	0.12-0.15	0.12-0.15	0.12-0.18	-			
	K2.1.C.UT	Grey cast iron Low tensile strength	180	4324	210	255	295	15.00-18.00	-	0.08-0.1	0.08-0.1	0.08-0.13	-	-	0.08-0.08	0.08-0.08	0.08-0.11	-
				4334	170	210	245	18.01-22.00	-	0.08-0.12	0.08-0.12	0.08-0.15	-	-	0.08-0.1	0.08-0.1	0.08-0.13	-
				4344	130	160	185	22.01-27.00	-	0.08-0.14	0.08-0.14	0.08-0.17	-	-	0.08-0.12	0.08-0.12	0.08-0.14	-
								27.01-33.00	-	0.1-0.16	0.1-0.16	0.1-0.19	-	-	0.1-0.13	0.1-0.13	0.1-0.16	-
								33.01-40.00	-	0.1-0.18	0.1-0.18	0.1-0.21	-	-	0.1-0.15	0.1-0.15	0.1-0.18	-
								40.01-52.00	-	0.12-0.18	0.12-0.18	0.12-0.21	-	-	0.12-0.15	0.12-0.15	0.12-0.18	-
					52.01-65.00	-	0.12-0.18	0.12-0.18	0.12-0.21	-	-	0.12-0.15	0.12-0.15	0.12-0.18	-			
	K2.2.C.UT	Grey cast iron High tensile strength	245	4324	125	185	220	15.00-18.00	-	0.08-0.08	0.08-0.08	0.08-0.12	-	-	0.08-0.07	0.08-0.07	0.08-0.1	-
				4334	100	145	175	18.01-22.00	-	0.08-0.1	0.08-0.1	0.08-0.14	-	-	0.08-0.09	0.08-0.09	0.08-0.12	-
				4344	75	115	135	22.01-27.00	-	0.08-0.12	0.08-0.12	0.08-0.16	-	-	0.08-0.1	0.08-0.1	0.08-0.13	-
								27.01-33.00	-	0.1-0.14	0.1-0.14	0.1-0.18	-	-	0.1-0.12	0.1-0.12	0.1-0.15	-
								33.01-40.00	-	0.1-0.16	0.1-0.16	0.1-0.2	-	-	0.1-0.14	0.1-0.14	0.1-0.17	-
								40.01-52.00	-	0.12-0.16	0.12-0.16	0.12-0.2	-	-	0.12-0.14	0.12-0.14	0.12-0.17	-
					52.01-65.00	-	0.12-0.16	0.12-0.16	0.12-0.2	-	-	0.12-0.14	0.12-0.14	0.12-0.17	-			
	K3.1.C.UT	Nodular cast iron Ferritic	155	4324	125	170	205	15.00-18.00	-	0.08-0.08	0.08-0.08	0.08-0.12	-	-	0.08-0.07	0.08-0.07	0.08-0.1	-
				4334	100	140	165	18.01-22.00	-	0.08-0.1	0.08-0.1	0.08-0.14	-	-	0.08-0.09	0.08-0.09	0.08-0.12	-
				4344	80	110	130	22.01-27.00	-	0.08-0.12	0.08-0.12	0.08-0.16	-	-	0.08-0.1	0.08-0.1	0.08-0.13	-
							27.01-33.00	-	0.1-0.14	0.1-0.14	0.1-0.18	-	-	0.1-0.12	0.1-0.12	0.1-0.15	-	
							33.01-40.00	-	0.1-0.16	0.1-0.16	0.1-0.2	-	-	0.1-0.14	0.1-0.14	0.1-0.17	-	
							40.01-52.00	-	0.12-0.16	0.12-0.16	0.12-0.2	-	-	0.12-0.14	0.12-0.14	0.12-0.17	-	
				52.01-65.00	-	0.12-0.16	0.12-0.16	0.12-0.2	-	-	0.12-0.14	0.12-0.14	0.12-0.17	-				
K3.3.C.UT	Nodular cast iron Pearlitic	265	4324	110	160	190	15.00-18.00	-	0.08-0.08	0.08-0.08	0.08-0.12	-	-	0.08-0.07	0.08-0.07	0.08-0.1	-	
			4334	90	130	160	18.01-22.00	-	0.08-0.1	0.08-0.1	0.08-0.14	-	-	0.08-0.09	0.08-0.09	0.08-0.12	-	
			4344	70	100	115	22.01-27.00	-	0.08-0.12	0.08-0.12	0.08-0.16	-	-	0.08-0.1	0.08-0.1	0.08-0.13	-	
							27.01-33.00	-	0.1-0.14	0.1-0.14	0.1-0.18	-	-	0.1-0.12	0.1-0.12	0.1-0.15	-	
							33.01-40.00	-	0.1-0.16	0.1-0.16	0.1-0.2	-	-	0.1-0.14	0.1-0.14	0.1-0.17	-	
							40.01-52.00	-	0.12-0.16	0.12-0.16	0.12-0.2	-	-	0.12-0.14	0.12-0.14	0.12-0.17	-	
				52.01-65.00	-	0.12-0.16	0.12-0.16	0.12-0.2	-	-	0.12-0.14	0.12-0.14	0.12-0.17	-				
K4.2.C.UT	Compacted graphite iron High tensile strength (Pearlite>90%)	230	4324	130	190	225	15.00-18.00	-	0.08-0.08	0.08-0.08	0.08-0.12	-	-	0.08-0.07	0.08-0.07	0.08-0.1	-	
			4334	110	155	180	18.01-22.00	-	0.08-0.1	0.08-0.1	0.08-0.14	-	-	0.08-0.09	0.08-0.09	0.08-0.12	-	
			4344	85	115	135	22.01-27.00	-	0.08-0.12	0.08-0.12	0.08-0.16	-	-	0.08-0.1	0.08-0.1	0.08-0.13	-	
							27.01-33.00	-	0.1-0.14	0.1-0.14	0.1-0.18	-	-	0.1-0.12	0.1-0.12	0.1-0.15	-	
							33.01-40.00	-	0.1-0.16	0.1-0.16	0.1-0.2	-	-	0.1-0.14	0.1-0.14	0.1-0.17	-	
							40.01-52.00	-	0.12-0.16	0.12-0.16	0.12-0.2	-	-	0.12-0.14	0.12-0.14	0.12-0.17	-	
				52.01-65.00	-	0.12-0.16	0.12-0.16	0.12-0.2	-	-	0.12-0.14	0.12-0.14	0.12-0.17	-				
H	H1.3.Z.HA	Extra hard steels Hardened and tempered	60 (HRC)	4324	30	60	75	15.00-18.00	-	0.06-0.08	0.06-0.08	0.06-0.08	-	-	0.06-0.07	0.06-0.07	0.06-0.07	-
				4334	30	60	75	18.01-22.00	-	0.06-0.09	0.06-0.09	0.06-0.09	-	-	0.06-0.08	0.06-0.08	0.06-0.08	-
				4344	30	60	75	22.01-27.00	-	0.06-0.1	0.06-0.1	0.06-0.1	-	-	0.06-0.08	0.06-0.08	0.06-0.08	-
								27.01-33.00	-	0.08-0.1	0.08-0.1	0.08-0.1	-	-	0.08-0.09	0.08-0.09	0.08-0.09	-
								33.01-40.00	-	0.08-0.12	0.08-0.12	0.08-0.12	-	-	0.08-0.1	0.08-0.1	0.08-0.1	-
								40.01-52.00	-	0.1-0.12	0.1-0.12	0.1-0.12	-	-	0.1-0.1	0.1-0.1	0.1-0.1	-
				52.01-65.00	-	0.1-0.12	0.1-0.12	0.1-0.12	-	-	0.1-0.1	0.1-0.1	0.1-0.1	-				

Feed at hole entry should be 75% of recommended feed rate. Feed at hole exit, use 0.05 mm/rev.

CoroDrill® DS20

6-7xD

Metric values

ISO	MC No.	Material	HB	Grade	Cutting speed recommendations			Drill diameter	Drill length 6xD					Drill length 7xD				
					6-7xD	-S5W	-L5W		-L6W	-M7W	-H5W	-S5W	-L5W	-L6W	-M7W	-H5W		
N	N1.2.Z.AG	Aluminium based alloys	100	H13A 4344	300	330	360	15.00-18.00	0.06-0.1	0.06-0.1	0.06-0.1	-	-	0.06-0.09	0.06-0.09	0.06-0.09	-	-
					300	330	360	18.01-22.00	0.06-0.12	0.06-0.12	0.06-0.12	-	-	0.06-0.1	0.06-0.1	0.06-0.1	-	-
		AISI alloys, Si ≤ 1%					22.01-27.00	0.06-0.13	0.06-0.13	0.06-0.13	-	-	0.06-0.11	0.06-0.11	0.06-0.11	-	-	
					27.01-33.00	0.08-0.14	0.08-0.14	0.08-0.14	-	-	0.08-0.12	0.08-0.12	0.08-0.12	-	-			
					33.01-40.00	0.08-0.16	0.08-0.16	0.08-0.16	-	-	0.08-0.14	0.08-0.14	0.08-0.14	-	-			
					40.01-52.00	0.1-0.16	0.1-0.16	0.1-0.16	-	-	0.1-0.14	0.1-0.14	0.1-0.14	-	-			
					52.01-65.00	0.1-0.16	0.1-0.16	0.1-0.16	-	-	0.1-0.14	0.1-0.14	0.1-0.14	-	-			
	N1.3.C.UT	Aluminium based alloys	75	H13A 4344	250	315	360	15.00-18.00	0.06-0.09	0.06-0.09	0.06-0.09	-	-	0.06-0.08	0.06-0.08	0.06-0.08	-	-
					250	315	360	18.01-22.00	0.06-0.1	0.06-0.1	0.06-0.1	-	-	0.06-0.09	0.06-0.09	0.06-0.09	-	-
		AISI cast alloys (1% < Si < 13%)					22.01-27.00	0.06-0.12	0.06-0.12	0.06-0.12	-	-	0.06-0.1	0.06-0.1	0.06-0.1	-	-	
					27.01-33.00	0.08-0.13	0.08-0.13	0.08-0.13	-	-	0.08-0.11	0.08-0.11	0.08-0.11	-	-			
					33.01-40.00	0.08-0.14	0.08-0.14	0.08-0.14	-	-	0.08-0.12	0.08-0.12	0.08-0.12	-	-			
					40.01-52.00	0.1-0.14	0.1-0.14	0.1-0.14	-	-	0.1-0.12	0.1-0.12	0.1-0.12	-	-			
					52.01-65.00	0.1-0.14	0.1-0.14	0.1-0.14	-	-	0.1-0.12	0.1-0.12	0.1-0.12	-	-			
	N1.3.C.AG	Aluminium based alloys	90	H13A 4344	250	285	315	15.00-18.00	0.06-0.09	0.06-0.09	0.06-0.09	-	-	0.06-0.08	0.06-0.08	0.06-0.08	-	-
					250	285	315	18.01-22.00	0.06-0.1	0.06-0.1	0.06-0.1	-	-	0.06-0.09	0.06-0.09	0.06-0.09	-	-
		AISI cast and aged alloys (1% < Si < 13%)					22.01-27.00	0.06-0.12	0.06-0.12	0.06-0.12	-	-	0.06-0.1	0.06-0.1	0.06-0.1	-	-	
					27.01-33.00	0.08-0.13	0.08-0.13	0.08-0.13	-	-	0.08-0.11	0.08-0.11	0.08-0.11	-	-			
					33.01-40.00	0.08-0.14	0.08-0.14	0.08-0.14	-	-	0.08-0.12	0.08-0.12	0.08-0.12	-	-			
					40.01-52.00	0.1-0.14	0.1-0.14	0.1-0.14	-	-	0.1-0.12	0.1-0.12	0.1-0.12	-	-			
					52.01-65.00	0.1-0.14	0.1-0.14	0.1-0.14	-	-	0.1-0.12	0.1-0.12	0.1-0.12	-	-			
	N3.3.U.UT	Copper based alloys	110	H13A 4344	250	315	360	15.00-18.00	0.06-0.1	0.06-0.1	0.06-0.1	-	-	0.06-0.09	0.06-0.09	0.06-0.09	-	-
					250	315	360	18.01-22.00	0.06-0.12	0.06-0.12	0.06-0.12	-	-	0.06-0.1	0.06-0.1	0.06-0.1	-	-
		Free cutting copper based alloys					22.01-27.00	0.06-0.13	0.06-0.13	0.06-0.13	-	-	0.06-0.11	0.06-0.11	0.06-0.11	-	-	
				27.01-33.00	0.08-0.14	0.08-0.14	0.08-0.14	-	-	0.08-0.12	0.08-0.12	0.08-0.12	-	-				
				33.01-40.00	0.08-0.16	0.08-0.16	0.08-0.16	-	-	0.08-0.14	0.08-0.14	0.08-0.14	-	-				
				40.01-52.00	0.1-0.16	0.1-0.16	0.1-0.16	-	-	0.1-0.14	0.1-0.14	0.1-0.14	-	-				
				52.01-65.00	0.1-0.16	0.1-0.16	0.1-0.16	-	-	0.1-0.14	0.1-0.14	0.1-0.14	-	-				
N3.2.C.UT	Copper based alloys	90	H13A 4344	180	200	215	15.00-18.00	0.06-0.1	0.06-0.1	0.06-0.1	-	-	0.06-0.09	0.06-0.09	0.06-0.09	-	-	
				180	200	215	18.01-22.00	0.06-0.12	0.06-0.12	0.06-0.12	-	-	0.06-0.1	0.06-0.1	0.06-0.1	-	-	
	Leaded brass and bronzes (Pb < 1%)					22.01-27.00	0.06-0.13	0.06-0.13	0.06-0.13	-	-	0.06-0.11	0.06-0.11	0.06-0.11	-	-		
				27.01-33.00	0.08-0.14	0.08-0.14	0.08-0.14	-	-	0.08-0.12	0.08-0.12	0.08-0.12	-	-				
				33.01-40.00	0.08-0.16	0.08-0.16	0.08-0.16	-	-	0.08-0.14	0.08-0.14	0.08-0.14	-	-				
				40.01-52.00	0.1-0.16	0.1-0.16	0.1-0.16	-	-	0.1-0.14	0.1-0.14	0.1-0.14	-	-				
				52.01-65.00	0.1-0.16	0.1-0.16	0.1-0.16	-	-	0.1-0.14	0.1-0.14	0.1-0.14	-	-				

Feed at hole entry should be 75% of recommended feed rate. Feed at hole exit, use 0.05 mm/rev.

CoroDrill® DS20

4-5xD

Inch values

ISO	MC No.	Material	HB	Grade	Cutting speed recommendations			Drill diameter	Drill length 4xD					Drill length 5xD				
					Min.	Rec.	Max.		-S5W	-L5W	-L6W	-M7W	-H5W	-S5W	-L5W	-L6W	-M7W	-H5W
			4-5xD			f_r inch/rev					f_r inch/rev							
P	P1.0.ZAN	Unalloyed steel C=0.05-0.10%	110	4324	755	1115	1310	0.591-0.709	0.002-0.003	0.002-0.003	0.002-0.003	-	0.002-0.004	0.002-0.003	0.002-0.003	0.002-0.003	-	0.002-0.004
				4334	690	935	1065	0.709-0.866	0.002-0.004	0.002-0.004	0.002-0.004	-	0.002-0.004	0.002-0.003	0.002-0.003	0.002-0.003	-	0.002-0.004
				4344	625	740	805	0.866-1.063	0.002-0.004	0.002-0.004	0.002-0.004	-	0.002-0.005	0.002-0.004	0.002-0.004	0.002-0.004	-	0.002-0.004
			1.063-1.299	0.002-0.004	0.002-0.004	0.002-0.004	-	0.002-0.005	0.002-0.004	0.002-0.004	0.002-0.004	-	0.002-0.005					
			1.299-1.575	0.002-0.005	0.002-0.005	0.002-0.005	-	0.002-0.006	0.002-0.004	0.002-0.004	0.002-0.004	-	0.002-0.006					
			1.575-2.047	0.002-0.005	0.002-0.005	0.002-0.005	-	0.002-0.006	0.002-0.004	0.002-0.004	0.002-0.004	-	0.002-0.006					
			2.047-2.559	0.002-0.005	0.002-0.005	0.002-0.005	-	0.002-0.006	0.002-0.004	0.002-0.004	0.002-0.004	-	0.002-0.006					
	P1.1.ZAN	Unalloyed steel C=0.05-0.25%	125	4324	755	1055	1215	0.591-0.709	0.002-0.004	0.002-0.004	0.002-0.004	-	0.002-0.004	0.002-0.004	0.002-0.004	0.002-0.004	-	0.002-0.004
				4334	655	880	1000	0.709-0.866	0.002-0.004	0.002-0.004	0.002-0.004	-	0.002-0.004	0.002-0.004	0.002-0.004	0.002-0.004	-	0.002-0.004
				4344	560	695	770	0.866-1.063	0.002-0.005	0.002-0.005	0.002-0.005	-	0.002-0.005	0.002-0.004	0.002-0.004	0.002-0.004	-	0.002-0.004
			1.063-1.299	0.002-0.005	0.002-0.005	0.002-0.005	-	0.002-0.005	0.002-0.004	0.002-0.004	0.002-0.004	-	0.002-0.005					
			1.299-1.575	0.002-0.006	0.002-0.006	0.002-0.006	-	0.002-0.006	0.002-0.004	0.002-0.004	0.002-0.004	-	0.002-0.006					
			1.575-2.047	0.002-0.006	0.002-0.006	0.002-0.006	-	0.002-0.006	0.002-0.004	0.002-0.004	0.002-0.004	-	0.002-0.006					
			2.047-2.559	0.002-0.006	0.002-0.006	0.002-0.006	-	0.002-0.006	0.002-0.004	0.002-0.004	0.002-0.004	-	0.002-0.006					
	P1.2.ZAN	Unalloyed steel C=0.25-0.55%	190	4324	625	870	1000	0.591-0.709	-	0.002-0.005	0.002-0.006	0.002-0.006	-	-	0.002-0.004	0.002-0.005	0.002-0.005	-
				4334	510	710	820	0.709-0.866	-	0.002-0.006	0.002-0.006	0.002-0.007	-	-	0.002-0.005	0.002-0.005	0.002-0.006	-
				4344	395	545	625	0.866-1.063	-	0.002-0.007	0.002-0.008	0.002-0.009	-	-	0.002-0.006	0.002-0.007	0.002-0.007	-
			1.063-1.299	-	0.003-0.009	0.003-0.009	0.003-0.01	-	-	0.003-0.007	0.003-0.008	0.003-0.009	-	-				
			1.299-1.575	-	0.003-0.009	0.003-0.01	0.003-0.011	-	-	0.003-0.008	0.003-0.009	0.003-0.009	-	-				
			1.575-2.047	-	0.004-0.009	0.004-0.01	0.004-0.011	-	-	0.004-0.008	0.004-0.009	0.004-0.009	-	-				
			2.047-2.559	-	0.004-0.009	0.004-0.01	0.004-0.011	-	-	0.004-0.008	0.004-0.009	0.004-0.009	-	-				
	P1.3.ZAN	Unalloyed steel C=0.55-0.80%	190	4324	560	815	950	0.591-0.709	-	0.002-0.005	0.002-0.006	0.002-0.006	-	-	0.002-0.004	0.002-0.005	0.002-0.005	-
				4334	460	670	785	0.709-0.866	-	0.002-0.006	0.002-0.006	0.002-0.007	-	-	0.002-0.005	0.002-0.005	0.002-0.006	-
				4344	345	515	605	0.866-1.063	-	0.002-0.007	0.002-0.008	0.002-0.009	-	-	0.002-0.006	0.002-0.007	0.002-0.007	-
1.063-1.299			-	0.003-0.009	0.003-0.009	0.003-0.01	-	-	0.003-0.007	0.003-0.008	0.003-0.009	-	-					
1.299-1.575			-	0.003-0.009	0.003-0.01	0.003-0.011	-	-	0.003-0.008	0.003-0.009	0.003-0.009	-	-					
1.575-2.047			-	0.004-0.009	0.004-0.01	0.004-0.011	-	-	0.004-0.008	0.004-0.009	0.004-0.009	-	-					
2.047-2.559			-	0.004-0.009	0.004-0.01	0.004-0.011	-	-	0.004-0.008	0.004-0.009	0.004-0.009	-	-					
P1.5.CUT	Unalloyed steel Cast - untreated	150	4324	460	855	1065	0.591-0.709	-	0.002-0.005	0.002-0.005	0.002-0.005	-	-	0.002-0.004	0.002-0.004	0.002-0.004	-	
			4334	445	720	870	0.709-0.866	-	0.002-0.005	0.002-0.005	0.002-0.005	-	-	0.002-0.004	0.002-0.004	0.002-0.004	-	
			4344	410	570	655	0.866-1.063	-	0.002-0.006	0.002-0.006	0.002-0.006	-	-	0.002-0.005	0.002-0.005	0.002-0.005	-	
		1.063-1.299	-	0.002-0.006	0.002-0.006	0.002-0.006	-	-	0.002-0.005	0.002-0.005	0.002-0.005	-	-					
		1.299-1.575	-	0.002-0.006	0.002-0.006	0.002-0.006	-	-	0.002-0.005	0.002-0.005	0.002-0.005	-	-					
		1.575-2.047	-	0.002-0.006	0.002-0.006	0.002-0.006	-	-	0.002-0.005	0.002-0.005	0.002-0.005	-	-					
		2.047-2.559	-	0.002-0.006	0.002-0.006	0.002-0.006	-	-	0.002-0.005	0.002-0.005	0.002-0.005	-	-					
P2.1.ZAN	Low alloy steel Annealed	175	4324	590	855	1000	0.591-0.709	-	-	0.002-0.006	0.002-0.006	-	-	0.002-0.005	0.002-0.005	0.002-0.005	-	
			4334	490	705	820	0.709-0.866	-	-	0.002-0.006	0.002-0.007	-	-	0.002-0.005	0.002-0.006	0.002-0.006	-	
			4344	375	540	625	0.866-1.063	-	-	0.002-0.008	0.002-0.009	-	-	0.002-0.007	0.002-0.007	0.002-0.007	-	
		1.063-1.299	-	-	0.003-0.009	0.003-0.01	-	-	0.003-0.008	0.003-0.008	0.003-0.009	-	-					
		1.299-1.575	-	-	0.003-0.01	0.003-0.011	-	-	0.003-0.009	0.003-0.009	0.003-0.009	-	-					
		1.575-2.047	-	-	0.004-0.01	0.004-0.011	-	-	0.004-0.009	0.004-0.009	0.004-0.009	-	-					
		2.047-2.559	-	-	0.004-0.01	0.004-0.011	-	-	0.004-0.009	0.004-0.009	0.004-0.009	-	-					
P2.2.ZAN	Low alloy steel Annealed	240	4324	590	825	950	0.591-0.709	-	-	0.002-0.006	0.002-0.006	-	-	0.002-0.005	0.002-0.005	0.002-0.005	-	
			4334	490	655	740	0.709-0.866	-	-	0.002-0.006	0.002-0.007	-	-	0.002-0.005	0.002-0.006	0.002-0.006	-	
			4344	375	565	670	0.866-1.063	-	-	0.002-0.008	0.002-0.009	-	-	0.002-0.007	0.002-0.007	0.002-0.007	-	
		1.063-1.299	-	-	0.003-0.009	0.003-0.01	-	-	0.003-0.008	0.003-0.008	0.003-0.009	-	-					
		1.299-1.575	-	-	0.003-0.01	0.003-0.011	-	-	0.003-0.009	0.003-0.009	0.003-0.009	-	-					
		1.575-2.047	-	-	0.004-0.01	0.004-0.011	-	-	0.004-0.009	0.004-0.009	0.004-0.009	-	-					
		2.047-2.559	-	-	0.004-0.01	0.004-0.011	-	-	0.004-0.009	0.004-0.009	0.004-0.009	-	-					
P2.6.CUT	Low alloy steel Cast - untreated	200	4324	360	690	870	0.591-0.709	-	-	0.002-0.006	0.002-0.007	-	-	0.002-0.005	0.002-0.006	0.002-0.006	-	
			4334	345	570	690	0.709-0.866	-	-	0.002-0.007	0.002-0.008	-	-	0.002-0.006	0.002-0.007	0.002-0.007	-	
			4344	330	455	525	0.866-1.063	-	-	0.002-0.009	0.002-0.009	-	-	0.002-0.007	0.002-0.008	0.002-0.008	-	
		1.063-1.299	-	-	0.003-0.01	0.003-0.011	-	-	0.003-0.009	0.003-0.009	0.003-0.009	-	-					
		1.299-1.575	-	-	0.003-0.011	0.003-0.012	-	-	0.003-0.009	0.003-0.009	0.003-0.009	-	-					
		1.575-2.047	-	-	0.004-0.011	0.004-0.012	-	-	0.004-0.009	0.004-0.01	0.004-0.01	-	-					
		2.047-2.559	-	-	0.004-0.011	0.004-0.012	-	-	0.004-0.009	0.004-0.01	0.004-0.01	-	-					
P3.0.ZAN	High alloy steel Annealed	200	4324	525	800	950	0.591-0.709	-	-	0.002-0.006	0.002-0.006	-	-	0.002-0.005	0.002-0.005	0.002-0.005	-	
			4334	425	660	785	0.709-0.866	-	-	0.002-0.006	0.002-0.007	-	-	0.002-0.005	0.002-0.006	0.002-0.006	-	
			4344	330	500	590	0.866-1.063	-	-	0.002-0.008	0.002-0.009	-	-	0.002-0.007	0.002-0.007	0.002-0.007	-	
		1.063-1.299	-	-	0.003-0.009	0.003-0.01	-	-	0.003-0.008	0.003-0.008	0.003-0.009	-	-					
		1.299-1.575	-	-	0.003-0.01	0.003-0.011	-	-	0.003-0.009	0.003-0.009	0.003-0.009	-	-					
		1.575-2.047	-	-	0.004-0.01	0.004-0.011	-	-	0.004-0.009	0.004-0.009	0.004-0.009	-	-					
		2.047-2.559	-	-	0.004-0.01	0.004-0.011	-	-	0.004-0.009	0.004-0.009	0.004-0.009	-	-					

CoroDrill® DS20

4-5xD

Inch values

ISO	MC No.	Material	HB	Grade	Cutting speed recommendations			Drill diameter	Drill length 4xD					Drill length 5xD						
					4-5xD	-S5W -L5W -L6W -M7W -H5W					-S5W -L5W -L6W -M7W -H5W									
						Recommended start value at middle of feed range					Recommended start value at middle of feed range									
P	P3.0.ZHT	High alloy steel Hardened and tempered	380	4324	260	540	690	0.591-0.709	-	-	0.002-0.006	0.002-0.006	-	-	-	0.002-0.005	0.002-0.005	-		
				4334	245	460	575	0.709-0.866	-	-	0.002-0.006	0.002-0.007	-	-	-	0.002-0.005	0.002-0.006	-		
				4344	230	355	425	0.866-1.063	-	-	0.002-0.008	0.002-0.009	-	-	-	0.002-0.007	0.002-0.007	-		
								1.063-1.299	-	-	0.003-0.009	0.003-0.01	-	-	-	0.003-0.008	0.003-0.009	-		
								1.299-1.575	-	-	0.003-0.01	0.003-0.011	-	-	-	0.003-0.009	0.003-0.009	-		
								1.575-2.047	-	-	0.004-0.01	0.004-0.011	-	-	-	0.004-0.009	0.004-0.009	-		
					2.047-2.559	-	-	0.004-0.01	0.004-0.011	-	-	-	0.004-0.009	0.004-0.009	-					
		P5.0.ZAN	Ferritic/martensitic stainless steel Annealed	200	4334	375	610	740	0.591-0.709	0.002-0.005	0.002-0.005	0.002-0.005	-	0.002-0.005	0.002-0.004	0.002-0.004	0.002-0.004	-	0.002-0.004	
	4344				375	505	575	0.709-0.866	0.002-0.006	0.002-0.006	0.002-0.006	-	0.002-0.005	0.002-0.005	0.002-0.005	0.002-0.005	-	0.002-0.005	-	0.002-0.004
	2044				375	480	540	0.866-1.063	0.002-0.006	0.002-0.006	0.002-0.006	-	0.002-0.006	0.002-0.005	0.002-0.005	0.002-0.005	-	0.002-0.005	-	0.002-0.005
								1.063-1.299	0.003-0.006	0.003-0.006	0.003-0.006	-	0.003-0.006	0.003-0.005	0.003-0.005	0.003-0.005	-	0.003-0.005	-	0.003-0.005
								1.299-1.575	0.003-0.007	0.003-0.007	0.003-0.007	-	0.003-0.006	0.003-0.006	0.003-0.006	0.003-0.006	-	0.003-0.006	-	0.003-0.005
							1.575-2.047	0.004-0.007	0.004-0.007	0.004-0.007	-	0.004-0.006	0.004-0.006	0.004-0.006	0.004-0.006	-	0.004-0.006	-	0.004-0.005	
				2.047-2.559	0.004-0.007	0.004-0.007	0.004-0.007	-	0.004-0.006	0.004-0.006	0.004-0.006	0.004-0.006	-	0.004-0.006	-	0.004-0.005				
	P5.0.ZHT	Ferritic/martensitic stainless steel Hardened and tempered	330	4334	245	450	560	0.591-0.709	0.002-0.005	0.002-0.005	0.002-0.005	-	0.002-0.005	0.002-0.004	0.002-0.004	0.002-0.004	-	0.002-0.004		
4344				230	380	460	0.709-0.866	0.002-0.006	0.002-0.006	0.002-0.006	-	0.002-0.005	0.002-0.005	0.002-0.005	0.002-0.005	-	0.002-0.005	-	0.002-0.004	
2044				230	380	460	0.866-1.063	0.002-0.006	0.002-0.006	0.002-0.006	-	0.002-0.006	0.002-0.005	0.002-0.005	0.002-0.005	-	0.002-0.005	-	0.002-0.005	
							1.063-1.299	0.003-0.006	0.003-0.006	0.003-0.006	-	0.003-0.006	0.003-0.005	0.003-0.005	0.003-0.005	-	0.003-0.005	-	0.003-0.005	
							1.299-1.575	0.003-0.007	0.003-0.007	0.003-0.007	-	0.003-0.006	0.003-0.006	0.003-0.006	0.003-0.006	-	0.003-0.006	-	0.003-0.005	
							1.575-2.047	0.004-0.007	0.004-0.007	0.004-0.007	-	0.004-0.006	0.004-0.006	0.004-0.006	0.004-0.006	-	0.004-0.006	-	0.004-0.005	
				2.047-2.559	0.004-0.007	0.004-0.007	0.004-0.007	-	0.004-0.006	0.004-0.006	0.004-0.006	0.004-0.006	-	0.004-0.006	-	0.004-0.005				
M	M1.0.ZAQ	Austenitic stainless steel Annealed/quenched	200	4334	375	610	740	0.591-0.709	0.002-0.005	0.002-0.005	0.002-0.005	-	0.002-0.004	0.002-0.004	0.002-0.004	0.002-0.004	-	0.002-0.004		
				4344	375	540	625	0.709-0.866	0.002-0.005	0.002-0.005	0.002-0.005	-	0.002-0.005	0.002-0.005	0.002-0.005	0.002-0.005	-	0.002-0.005		
				2044	375	515	590	0.866-1.063	0.002-0.006	0.002-0.006	0.002-0.006	-	0.002-0.005	0.002-0.005	0.002-0.005	0.002-0.005	-	0.002-0.005		
								1.063-1.299	0.003-0.006	0.003-0.006	0.003-0.006	-	0.003-0.006	0.003-0.005	0.003-0.005	0.003-0.005	-	0.003-0.005		
								1.299-1.575	0.003-0.006	0.003-0.006	0.003-0.006	-	0.003-0.006	0.003-0.006	0.003-0.006	0.003-0.006	-	0.003-0.005		
								1.575-2.047	0.004-0.006	0.004-0.006	0.004-0.006	-	0.004-0.006	0.004-0.006	0.004-0.006	0.004-0.006	-	0.004-0.005		
					2.047-2.559	0.004-0.006	0.004-0.006	0.004-0.006	-	0.004-0.006	0.004-0.006	0.004-0.006	0.004-0.006	-	0.004-0.005					
		M1.1.ZAQ	Austenitic stainless steel Machinability improved	200	4334	375	640	785	0.591-0.709	0.002-0.005	0.002-0.005	0.002-0.005	-	0.002-0.004	0.002-0.004	0.002-0.004	0.002-0.004	-	0.002-0.004	
	4344				375	580	690	0.709-0.866	0.002-0.005	0.002-0.005	0.002-0.005	-	0.002-0.005	0.002-0.005	0.002-0.005	0.002-0.005	-	0.002-0.005		
	2044				375	555	655	0.866-1.063	0.002-0.006	0.002-0.006	0.002-0.006	-	0.002-0.005	0.002-0.005	0.002-0.005	0.002-0.005	-	0.002-0.005		
								1.063-1.299	0.003-0.006	0.003-0.006	0.003-0.006	-	0.003-0.006	0.003-0.005	0.003-0.005	0.003-0.005	-	0.003-0.005		
								1.299-1.575	0.003-0.006	0.003-0.006	0.003-0.006	-	0.003-0.006	0.003-0.006	0.003-0.006	0.003-0.006	-	0.003-0.005		
								1.575-2.047	0.004-0.006	0.004-0.006	0.004-0.006	-	0.004-0.006	0.004-0.006	0.004-0.006	0.004-0.006	-	0.004-0.005		
					2.047-2.559	0.004-0.006	0.004-0.006	0.004-0.006	-	0.004-0.006	0.004-0.006	0.004-0.006	0.004-0.006	-	0.004-0.005					
		M2.0.ZAQ	Super austenitic (Ni>20%) stainless steel Annealed/quenched	200	4334	260	410	490	0.591-0.709	0.002-0.005	0.002-0.005	0.002-0.005	-	0.002-0.004	0.002-0.004	0.002-0.004	0.002-0.004	-	0.002-0.004	
	4344				260	360	410	0.709-0.866	0.002-0.005	0.002-0.005	0.002-0.005	-	0.002-0.005	0.002-0.005	0.002-0.005	0.002-0.005	-	0.002-0.004		
	2044				260	360	410	0.866-1.063	0.002-0.006	0.002-0.006	0.002-0.006	-	0.002-0.005	0.002-0.005	0.002-0.005	0.002-0.005	-	0.002-0.005		
								1.063-1.299	0.003-0.006	0.003-0.006	0.003-0.006	-	0.003-0.006	0.003-0.005	0.003-0.005	0.003-0.005	-	0.003-0.005		
							1.299-1.575	0.003-0.006	0.003-0.006	0.003-0.006	-	0.003-0.006	0.003-0.006	0.003-0.006	0.003-0.006	-	0.003-0.005			
							1.575-2.047	0.004-0.006	0.004-0.006	0.004-0.006	-	0.004-0.006	0.004-0.006	0.004-0.006	0.004-0.006	-	0.004-0.005			
				2.047-2.559	0.004-0.006	0.004-0.006	0.004-0.006	-	0.004-0.006	0.004-0.006	0.004-0.006	0.004-0.006	-	0.004-0.005						
	M3.1.ZAQ	Duplex stainless steel >60% ferrite (N<0.10%)	230	4334	280	405	475	0.591-0.709	0.002-0.005	0.002-0.005	0.002-0.005	-	0.002-0.004	0.002-0.004	0.002-0.004	0.002-0.004	-	0.002-0.004		
4344				280	375	425	0.709-0.866	0.002-0.005	0.002-0.005	0.002-0.005	-	0.002-0.005	0.002-0.005	0.002-0.005	0.002-0.005	-	0.002-0.004			
2044				280	365	410	0.866-1.063	0.002-0.006	0.002-0.006	0.002-0.006	-	0.002-0.005	0.002-0.005	0.002-0.005	0.002-0.005	-	0.002-0.005			
							1.063-1.299	0.003-0.006	0.003-0.006	0.003-0.006	-	0.003-0.006	0.003-0.005	0.003-0.005	0.003-0.005	-	0.003-0.005			
							1.299-1.575	0.003-0.006	0.003-0.006	0.003-0.006	-	0.003-0.006	0.003-0.006	0.003-0.006	0.003-0.006	-	0.003-0.005			
							1.575-2.047	0.004-0.006	0.004-0.006	0.004-0.006	-	0.004-0.006	0.004-0.006	0.004-0.006	0.004-0.006	-	0.004-0.005			
				2.047-2.559	0.004-0.006	0.004-0.006	0.004-0.006	-	0.004-0.006	0.004-0.006	0.004-0.006	0.004-0.006	-	0.004-0.005						
	M3.2.ZAQ	Duplex stainless steel <60% ferrite (N≥0.10%)	260	4334	245	345	395	0.591-0.709	0.002-0.005	0.002-0.005	0.002-0.005	-	0.002-0.004	0.002-0.004	0.002-0.004	0.002-0.004	-	0.002-0.004		
4344				245	330	375	0.709-0.866	0.002-0.005	0.002-0.005	0.002-0.005	-	0.002-0.005	0.002-0.005	0.002-0.005	0.002-0.005	-	0.002-0.004			
2044				245	330	375	0.866-1.063	0.002-0.006	0.002-0.006	0.002-0.006	-	0.002-0.005	0.002-0.005	0.002-0.005	0.002-0.005	-	0.002-0.005			
							1.063-1.299	0.003-0.006	0.003-0.006	0.003-0.006	-	0.003-0.006	0.003-0.005	0.003-0.005	0.003-0.005	-	0.003-0.005			
							1.299-1.575	0.003-0.006	0.003-0.006	0.003-0.006	-	0.003-0.006	0.003-0.006	0.003-0.006	0.003-0.006	-	0.003-0.005			
							1.575-2.047	0.004-0.006	0.004-0.006	0.004-0.006	-	0.004-0.006	0.004-0.006	0.004-0.006	0.004-0.006	-	0.004-0.005			
				2.047-2.559	0.004-0.006	0.004-0.006	0.004-0.006	-	0.00											

CoroDrill® DS20

4-5xD

Inch values

ISO	MC No.	Material	HB	Grade	Cutting speed recommendations			Drill diameter	Drill length 4xD					Drill length 5xD				
					4-5xD	-S5W	-L5W		-L6W	-M7W	-H5W	-S5W	-L5W	-L6W	-M7W	-H5W		
																	Recommended start value at middle of feed range	
K	K1.1.C.NS	Malleable cast iron Low tensile strength	200	4324	460	685	805	0.591-0.709	-	0.003-0.006	0.003-0.006	0.003-0.008	-	-	0.003-0.005	0.003-0.005	0.003-0.007	-
				4334	360	550	655	0.709-0.866	-	0.003-0.007	0.003-0.007	0.003-0.009	-	-	0.003-0.006	0.003-0.006	0.003-0.008	-
				4344	590	540	510	0.866-1.063	-	0.003-0.008	0.003-0.008	0.003-0.01	-	-	0.003-0.007	0.003-0.007	0.003-0.009	-
			1.063-1.299	-	0.004-0.009	0.004-0.009	0.004-0.011	-	-	0.004-0.008	0.004-0.008	0.004-0.01	-					
			1.299-1.575	-	0.004-0.011	0.004-0.011	0.004-0.013	-	-	0.004-0.009	0.004-0.009	0.004-0.011	-					
			1.575-2.047	-	0.005-0.011	0.005-0.011	0.005-0.013	-	-	0.005-0.009	0.005-0.009	0.005-0.011	-					
	2.047-2.559	-	0.005-0.011	0.005-0.011	0.005-0.013	-	-	0.005-0.009	0.005-0.009	0.005-0.011	-							
	K2.1.C.UT	Grey cast iron Low tensile strength	180	4324	690	935	1065	0.591-0.709	-	0.003-0.006	0.003-0.006	0.003-0.008	-	-	0.003-0.005	0.003-0.005	0.003-0.007	-
				4334	560	770	885	0.709-0.866	-	0.003-0.007	0.003-0.007	0.003-0.009	-	-	0.003-0.006	0.003-0.006	0.003-0.008	-
				4344	425	585	670	0.866-1.063	-	0.003-0.008	0.003-0.008	0.003-0.01	-	-	0.003-0.007	0.003-0.007	0.003-0.009	-
			1.063-1.299	-	0.004-0.009	0.004-0.009	0.004-0.011	-	-	0.004-0.008	0.004-0.008	0.004-0.01	-					
			1.299-1.575	-	0.004-0.011	0.004-0.011	0.004-0.013	-	-	0.004-0.009	0.004-0.009	0.004-0.011	-					
			1.575-2.047	-	0.005-0.011	0.005-0.011	0.005-0.013	-	-	0.005-0.009	0.005-0.009	0.005-0.011	-					
	2.047-2.559	-	0.005-0.011	0.005-0.011	0.005-0.013	-	-	0.005-0.009	0.005-0.009	0.005-0.011	-							
	K2.2.C.UT	Grey cast iron High tensile strength	245	4324	410	665	805	0.591-0.709	-	0.003-0.005	0.003-0.005	0.003-0.007	-	-	0.003-0.004	0.003-0.004	0.003-0.006	-
				4334	330	530	640	0.709-0.866	-	0.003-0.006	0.003-0.006	0.003-0.008	-	-	0.003-0.005	0.003-0.005	0.003-0.007	-
				4344	245	405	490	0.866-1.063	-	0.003-0.007	0.003-0.007	0.003-0.009	-	-	0.003-0.006	0.003-0.006	0.003-0.008	-
			1.063-1.299	-	0.004-0.009	0.004-0.009	0.004-0.011	-	-	0.004-0.007	0.004-0.007	0.004-0.009	-					
			1.299-1.575	-	0.004-0.01	0.004-0.01	0.004-0.012	-	-	0.004-0.008	0.004-0.008	0.004-0.01	-					
			1.575-2.047	-	0.005-0.01	0.005-0.01	0.005-0.012	-	-	0.005-0.008	0.005-0.008	0.005-0.01	-					
	2.047-2.559	-	0.005-0.01	0.005-0.01	0.005-0.012	-	-	0.005-0.008	0.005-0.008	0.005-0.01	-							
	K3.1.C.UT	Nodular cast iron Ferritic	155	4324	410	625	740	0.591-0.709	-	0.003-0.005	0.003-0.005	0.003-0.007	-	-	0.003-0.004	0.003-0.004	0.003-0.006	-
				4334	330	510	605	0.709-0.866	-	0.003-0.006	0.003-0.006	0.003-0.008	-	-	0.003-0.005	0.003-0.005	0.003-0.007	-
				4344	260	400	475	0.866-1.063	-	0.003-0.007	0.003-0.007	0.003-0.009	-	-	0.003-0.006	0.003-0.006	0.003-0.008	-
1.063-1.299			-	0.004-0.009	0.004-0.009	0.004-0.011	-	-	0.004-0.007	0.004-0.007	0.004-0.009	-						
1.299-1.575			-	0.004-0.01	0.004-0.01	0.004-0.012	-	-	0.004-0.008	0.004-0.008	0.004-0.01	-						
1.575-2.047			-	0.005-0.01	0.005-0.01	0.005-0.012	-	-	0.005-0.008	0.005-0.008	0.005-0.01	-						
2.047-2.559	-	0.005-0.01	0.005-0.01	0.005-0.012	-	-	0.005-0.008	0.005-0.008	0.005-0.01	-								
K3.3.C.UT	Nodular cast iron Ferritic	265	4324	360	575	690	0.591-0.709	-	0.003-0.005	0.003-0.005	0.003-0.007	-	-	0.003-0.004	0.003-0.004	0.003-0.006	-	
			4334	295	475	575	0.709-0.866	-	0.003-0.006	0.003-0.006	0.003-0.008	-	-	0.003-0.005	0.003-0.005	0.003-0.007	-	
			4344	230	355	425	0.866-1.063	-	0.003-0.007	0.003-0.007	0.003-0.009	-	-	0.003-0.006	0.003-0.006	0.003-0.008	-	
		1.063-1.299	-	0.004-0.009	0.004-0.009	0.004-0.011	-	-	0.004-0.007	0.004-0.007	0.004-0.009	-						
		1.299-1.575	-	0.004-0.01	0.004-0.01	0.004-0.012	-	-	0.004-0.008	0.004-0.008	0.004-0.01	-						
		1.575-2.047	-	0.005-0.01	0.005-0.01	0.005-0.012	-	-	0.005-0.008	0.005-0.008	0.005-0.01	-						
2.047-2.559	-	0.005-0.01	0.005-0.01	0.005-0.012	-	-	0.005-0.008	0.005-0.008	0.005-0.01	-								
K4.2.C.UT	Compacted graphite iron High tensile strength	230	4324	425	680	820	0.591-0.709	-	0.003-0.005	0.003-0.005	0.003-0.007	-	-	0.003-0.004	0.003-0.004	0.003-0.006	-	
			4334	360	550	655	0.709-0.866	-	0.003-0.006	0.003-0.006	0.003-0.008	-	-	0.003-0.005	0.003-0.005	0.003-0.007	-	
			4344	280	415	490	0.866-1.063	-	0.003-0.007	0.003-0.007	0.003-0.009	-	-	0.003-0.006	0.003-0.006	0.003-0.008	-	
		1.063-1.299	-	0.004-0.009	0.004-0.009	0.004-0.011	-	-	0.004-0.007	0.004-0.007	0.004-0.009	-						
		1.299-1.575	-	0.004-0.01	0.004-0.01	0.004-0.012	-	-	0.004-0.008	0.004-0.008	0.004-0.01	-						
		1.575-2.047	-	0.005-0.01	0.005-0.01	0.005-0.012	-	-	0.005-0.008	0.005-0.008	0.005-0.01	-						
2.047-2.559	-	0.005-0.01	0.005-0.01	0.005-0.012	-	-	0.005-0.008	0.005-0.008	0.005-0.01	-								
H	H1.3.Z.HA	Extra hard steel Hardened and tempered (HRC)	60	4324	100	215	280	0.591-0.709	-	0.002-0.005	0.002-0.005	0.002-0.005	-	-	0.002-0.004	0.002-0.004	0.002-0.004	-
				4334	100	215	280	0.709-0.866	-	0.002-0.006	0.002-0.006	0.002-0.006	-	-	0.002-0.005	0.002-0.005	0.002-0.005	-
				4344	100	215	280	0.866-1.063	-	0.002-0.006	0.002-0.006	0.002-0.006	-	-	0.002-0.005	0.002-0.005	0.002-0.005	-
			1.063-1.299	-	0.003-0.006	0.003-0.006	0.003-0.006	-	-	0.003-0.005	0.003-0.005	0.003-0.005	-					
			1.299-1.575	-	0.003-0.007	0.003-0.007	0.003-0.007	-	-	0.003-0.006	0.003-0.006	0.003-0.006	-					
			1.575-2.047	-	0.004-0.007	0.004-0.007	0.004-0.007	-	-	0.004-0.006	0.004-0.006	0.004-0.006	-					
2.047-2.559	-	0.004-0.007	0.004-0.007	0.004-0.007	-	-	0.004-0.006	0.004-0.006	0.004-0.006	-								

CoroDrill® DS20

4-5xD

Inch values

ISO	MC No.	Material	HB	Grade	Cutting speed recommendations			Drill diameter	Drill length 4xD					Drill length 5xD				
									-S5W	-L5W	-L6W	-M7W	-H5W	-S5W	-L5W	-L6W	-M7W	-H5W
					4-5xD				Recommended start value at middle of feed range									
N	N1.2.ZAG	Aluminium based alloys AISI alloys, Si ≤ 1%	100	H13A 4344	985	1195	1310	0.591-0.709	0.002-0.006	0.002-0.006	0.002-0.006	-	-	0.002-0.005	0.002-0.005	0.002-0.005	-	-
					985	1195	1310	0.709-0.866	0.002-0.007	0.002-0.007	0.002-0.007	-	-	0.002-0.006	0.002-0.006	0.002-0.006	-	-
			0.866-1.063	0.002-0.008	0.002-0.008	0.002-0.008	-	-	0.002-0.007	0.002-0.007	0.002-0.007	-	-					
			1.063-1.299	0.003-0.009	0.003-0.009	0.003-0.009	-	-	0.003-0.007	0.003-0.007	0.003-0.007	-	-					
			1.299-1.575	0.003-0.01	0.003-0.01	0.003-0.01	-	-	0.003-0.008	0.003-0.008	0.003-0.008	-	-					
			1.575-2.047	0.004-0.01	0.004-0.01	0.004-0.01	-	-	0.004-0.008	0.004-0.008	0.004-0.008	-	-					
	2.047-2.559	0.004-0.01	0.004-0.01	0.004-0.01	-	-	0.004-0.008	0.004-0.008	0.004-0.008	-	-							
	N1.3.C.UT	Aluminium based alloys AISI alloys, Si ≤ 1%	75	H13A 4344	820	1140	1310	0.591-0.709	0.002-0.006	0.002-0.006	0.002-0.006	-	-	0.002-0.005	0.002-0.005	0.002-0.005	-	-
					820	1140	1310	0.709-0.866	0.002-0.006	0.002-0.006	0.002-0.006	-	-	0.002-0.005	0.002-0.005	0.002-0.005	-	-
			0.866-1.063	0.002-0.007	0.002-0.007	0.002-0.007	-	-	0.002-0.006	0.002-0.006	0.002-0.006	-	-					
			1.063-1.299	0.003-0.008	0.003-0.008	0.003-0.008	-	-	0.003-0.007	0.003-0.007	0.003-0.007	-	-					
			1.299-1.575	0.003-0.009	0.003-0.009	0.003-0.009	-	-	0.003-0.007	0.003-0.007	0.003-0.007	-	-					
			1.575-2.047	0.004-0.009	0.004-0.009	0.004-0.009	-	-	0.004-0.007	0.004-0.007	0.004-0.007	-	-					
	2.047-2.559	0.004-0.009	0.004-0.009	0.004-0.009	-	-	0.004-0.007	0.004-0.007	0.004-0.007	-	-							
	N1.3.C.AG	Aluminium based alloys AISI cast and aged alloys (1% < Si < 13%)	90	H13A 4344	820	1035	1150	0.591-0.709	0.002-0.006	0.002-0.006	0.002-0.006	-	-	0.002-0.005	0.002-0.005	0.002-0.005	-	-
					820	1035	1150	0.709-0.866	0.002-0.006	0.002-0.006	0.002-0.006	-	-	0.002-0.005	0.002-0.005	0.002-0.005	-	-
			0.866-1.063	0.002-0.007	0.002-0.007	0.002-0.007	-	-	0.002-0.006	0.002-0.006	0.002-0.006	-	-					
			1.063-1.299	0.003-0.008	0.003-0.008	0.003-0.008	-	-	0.003-0.007	0.003-0.007	0.003-0.007	-	-					
			1.299-1.575	0.003-0.009	0.003-0.009	0.003-0.009	-	-	0.003-0.007	0.003-0.007	0.003-0.007	-	-					
			1.575-2.047	0.004-0.009	0.004-0.009	0.004-0.009	-	-	0.004-0.007	0.004-0.007	0.004-0.007	-	-					
	2.047-2.559	0.004-0.009	0.004-0.009	0.004-0.009	-	-	0.004-0.007	0.004-0.007	0.004-0.007	-	-							
	N3.3.U.UT	Copper based alloys Free cutting copper based alloys	110	H13A 4344	820	1140	1310	0.591-0.709	0.002-0.006	0.002-0.006	0.002-0.006	-	-	0.002-0.005	0.002-0.005	0.002-0.005	-	-
					820	1140	1310	0.709-0.866	0.002-0.007	0.002-0.007	0.002-0.007	-	-	0.002-0.006	0.002-0.006	0.002-0.006	-	-
			0.866-1.063	0.002-0.008	0.002-0.008	0.002-0.008	-	-	0.002-0.007	0.002-0.007	0.002-0.007	-	-					
1.063-1.299			0.003-0.009	0.003-0.009	0.003-0.009	-	-	0.003-0.007	0.003-0.007	0.003-0.007	-	-						
1.299-1.575			0.003-0.01	0.003-0.01	0.003-0.01	-	-	0.003-0.008	0.003-0.008	0.003-0.008	-	-						
1.575-2.047			0.004-0.01	0.004-0.01	0.004-0.01	-	-	0.004-0.008	0.004-0.008	0.004-0.008	-	-						
2.047-2.559	0.004-0.01	0.004-0.01	0.004-0.01	-	-	0.004-0.008	0.004-0.008	0.004-0.008	-	-								
N3.2.C.UT	Copper based alloys Leaded brass & bronzes (Pb ≤ 1%)	90	H13A 4344	590	715	785	0.591-0.709	0.002-0.006	0.002-0.006	0.002-0.006	-	-	0.002-0.005	0.002-0.005	0.002-0.005	-	-	
				590	715	785	0.709-0.866	0.002-0.007	0.002-0.007	0.002-0.007	-	-	0.002-0.006	0.002-0.006	0.002-0.006	-	-	
		0.866-1.063	0.002-0.008	0.002-0.008	0.002-0.008	-	-	0.002-0.007	0.002-0.007	0.002-0.007	-	-						
		1.063-1.299	0.003-0.009	0.003-0.009	0.003-0.009	-	-	0.003-0.007	0.003-0.007	0.003-0.007	-	-						
		1.299-1.575	0.003-0.01	0.003-0.01	0.003-0.01	-	-	0.003-0.008	0.003-0.008	0.003-0.008	-	-						
		1.575-2.047	0.004-0.01	0.004-0.01	0.004-0.01	-	-	0.004-0.008	0.004-0.008	0.004-0.008	-	-						
2.047-2.559	0.004-0.01	0.004-0.01	0.004-0.01	-	-	0.004-0.008	0.004-0.008	0.004-0.008	-	-								

CoroDrill® DS20

6-7xD

Inch values

ISO	MC No.	Material	HB	Grade	Cutting speed recommendations			Drill diameter	Drill length 6xD					Drill length 7xD					
					Min.	Rec.	Max.		-S5W	-L5W	-L6W	-M7W	-H5W	-S5W	-L5W	-L6W	-M7W	-H5W	
																			Recommended start value at middle of feed range
			6-7xD			fn inch/rev					fn inch/rev								
P	P1.0.ZAN	Unalloyed steel C=0.05-0.10%	110	4324	755	1005	1180	0.591-0.709	0.002-0.003	0.002-0.003	0.002-0.003	-	0.002-0.003	0.002-0.002	0.002-0.002	-	0.002-0.003		
				4334	690	840	960	0.709-0.866	0.002-0.003	0.002-0.003	0.002-0.003	-	0.002-0.003	0.002-0.002	0.002-0.002	-	0.002-0.003		
				4344	625	665	725	0.866-1.063	0.002-0.003	0.002-0.003	0.002-0.003	-	0.002-0.004	0.002-0.003	0.002-0.003	-	0.002-0.003		
			P1.1.ZAN	Unalloyed steel C=0.05-0.25%	125	4324	755	950	1095	0.591-0.709	0.002-0.003	0.002-0.003	0.002-0.003	-	0.002-0.003	0.002-0.003	0.002-0.003	-	0.002-0.003
						4334	655	790	900	0.709-0.866	0.002-0.003	0.002-0.003	0.002-0.003	-	0.002-0.003	0.002-0.003	0.002-0.003	-	0.002-0.003
						4344	560	625	695	0.866-1.063	0.002-0.004	0.002-0.004	0.002-0.004	-	0.002-0.004	0.002-0.003	0.002-0.003	-	0.002-0.003
	P1.2.ZAN	Unalloyed steel C=0.25-0.55%	190	4324	625	785	900	0.591-0.709	-	0.002-0.003	0.002-0.004	0.002-0.004	-	-	0.002-0.003	0.002-0.003	0.002-0.003		
				4334	510	640	740	0.709-0.866	-	0.002-0.004	0.002-0.004	0.002-0.005	-	-	0.002-0.003	0.002-0.003	0.002-0.004		
				4344	395	490	565	0.866-1.063	-	0.003-0.006	0.003-0.006	0.003-0.007	-	-	0.003-0.005	0.003-0.005	0.003-0.006		
	P1.3.ZAN	Unalloyed steel C=0.55-0.80%	190	4324	560	735	855	0.591-0.709	-	0.002-0.003	0.002-0.004	0.002-0.004	-	-	0.002-0.003	0.002-0.003	0.002-0.003		
				4334	460	605	705	0.709-0.866	-	0.002-0.004	0.002-0.004	0.002-0.005	-	-	0.002-0.003	0.002-0.003	0.002-0.004		
				4344	345	465	545	0.866-1.063	-	0.003-0.006	0.003-0.006	0.003-0.007	-	-	0.003-0.005	0.003-0.005	0.003-0.006		
P1.5.CUT	Unalloyed steel Cast - untreated	150	4324	460	770	960	0.591-0.709	-	0.002-0.003	0.002-0.003	0.002-0.003	-	-	0.002-0.003	0.002-0.003	0.002-0.003			
			4334	445	650	785	0.709-0.866	-	0.002-0.003	0.002-0.003	0.002-0.003	-	-	0.002-0.003	0.002-0.003	0.002-0.003			
			4344	410	515	590	0.866-1.063	-	0.002-0.004	0.002-0.004	0.002-0.004	-	-	0.002-0.003	0.002-0.003	0.002-0.003			
P2.1.ZAN	Low alloy steel Annealed	175	4324	590	770	900	0.591-0.709	-	-	0.002-0.004	0.002-0.004	-	-	0.002-0.003	0.002-0.003	-			
			4334	490	635	740	0.709-0.866	-	-	0.002-0.005	0.002-0.006	-	-	0.002-0.004	0.002-0.005	-			
			4344	375	485	565	0.866-1.063	-	-	0.003-0.006	0.003-0.007	-	-	0.003-0.005	0.003-0.006	-			
P2.2.ZAN	Low alloy steel Annealed	240	4324	590	745	855	0.591-0.709	-	-	0.002-0.004	0.002-0.004	-	-	0.002-0.003	0.002-0.003	-			
			4334	490	590	665	0.709-0.866	-	-	0.002-0.005	0.002-0.006	-	-	0.002-0.004	0.002-0.005	-			
			4344	375	510	605	0.866-1.063	-	-	0.003-0.006	0.003-0.007	-	-	0.003-0.005	0.003-0.006	-			
P2.5.ZHT	Low alloy steel Hardened and tempered	330	4324	295	565	725	0.591-0.709	-	-	0.002-0.004	0.002-0.004	-	-	0.002-0.003	0.002-0.003	-			
			4334	280	465	575	0.709-0.866	-	-	0.002-0.005	0.002-0.006	-	-	0.002-0.004	0.002-0.005	-			
			4344	245	365	440	0.866-1.063	-	-	0.003-0.006	0.003-0.007	-	-	0.003-0.005	0.003-0.006	-			
P2.6.CUT	Low alloy steel Cast - untreated	200	4324	360	620	785	0.591-0.709	-	-	0.002-0.004	0.002-0.005	-	-	0.002-0.003	0.002-0.004	-			
			4334	345	515	620	0.709-0.866	-	-	0.002-0.005	0.002-0.006	-	-	0.002-0.004	0.002-0.005	-			
			4344	330	410	475	0.866-1.063	-	-	0.003-0.007	0.003-0.008	-	-	0.003-0.006	0.003-0.006	-			
P3.0.ZAN	High alloy steel Annealed	200	4324	525	720	855	0.591-0.709	-	-	0.002-0.004	0.002-0.004	-	-	0.002-0.003	0.002-0.003	-			
			4334	425	595	705	0.709-0.866	-	-	0.002-0.005	0.002-0.006	-	-	0.002-0.004	0.002-0.005	-			
			4344	330	450	530	0.866-1.063	-	-	0.003-0.006	0.003-0.007	-	-	0.003-0.005	0.003-0.006	-			



CoroDrill® DS20

6-7xD

Inch values

ISO	MC No.	Material	HB	Grade	Cutting speed recommendations			Drill diameter	Drill length 6xD					Drill length 7xD				
									-S5W	-L5W	-L6W	-M7W	-H5W	-S5W	-L5W	-L6W	-M7W	-H5W
					6-7xD					Recommended start value at middle of feed range					Recommended start value at middle of feed range			
P	P3.0.ZHT	High alloy steel Hardened and tempered	380	4324	260	485	620	0.591-0.709	-	-	0.002-0.004	0.002-0.004	-	-	-	0.002-0.003	0.002-0.003	-
				4334	245	415	520	0.709-0.866	-	-	0.002-0.004	0.002-0.005	-	-	-	0.002-0.003	0.002-0.004	-
				4344	230	320	385	0.866-1.063	-	-	0.002-0.005	0.002-0.006	-	-	-	0.002-0.004	0.002-0.005	-
								1.063-1.299	-	-	0.003-0.006	0.003-0.007	-	-	-	0.003-0.005	0.003-0.006	-
								1.299-1.575	-	-	0.003-0.007	0.003-0.007	-	-	-	0.003-0.006	0.003-0.006	-
								1.575-2.047	-	-	0.004-0.007	0.004-0.007	-	-	-	0.004-0.006	0.004-0.006	-
					2.047-2.559	-	-	0.004-0.007	0.004-0.007	-	-	-	0.004-0.006	0.004-0.006	-			
	P5.0.ZAN	Ferritic/martensitic stainless steel Annealed	200	4334	375	560	665	0.591-0.709	0.002-0.003	0.002-0.003	0.002-0.003	-	0.002-0.003	0.002-0.003	0.002-0.003	0.002-0.003	-	0.002-0.003
				4344	375	455	520	0.709-0.866	0.002-0.004	0.002-0.004	0.002-0.004	-	0.002-0.003	0.002-0.003	0.002-0.003	0.002-0.003	-	0.002-0.003
				2044	375	430	485	0.866-1.063	0.002-0.004	0.002-0.004	0.002-0.004	-	0.002-0.004	0.002-0.003	0.002-0.003	0.002-0.003	-	0.002-0.003
								1.063-1.299	0.003-0.004	0.003-0.004	0.003-0.004	-	0.003-0.004	0.003-0.003	0.003-0.003	0.003-0.003	-	0.003-0.003
								1.299-1.575	0.003-0.005	0.003-0.005	0.003-0.005	-	0.003-0.004	0.003-0.004	0.003-0.004	0.003-0.004	-	0.003-0.003
							1.575-2.047	0.004-0.005	0.004-0.005	0.004-0.005	-	0.004-0.004	0.004-0.004	0.004-0.004	0.004-0.004	-	0.004-0.003	
				2.047-2.559	0.004-0.005	0.004-0.005	0.004-0.005	-	0.004-0.004	0.004-0.004	0.004-0.004	0.004-0.004	-	0.004-0.003				
P5.0.ZHT	Ferritic/martensitic stainless steel Hardened and tempered	330	4334	245	405	505	0.591-0.709	0.002-0.003	0.002-0.003	0.002-0.003	-	0.002-0.003	0.002-0.003	0.002-0.003	0.002-0.003	-	0.002-0.003	
			4344	230	340	415	0.709-0.866	0.002-0.004	0.002-0.004	0.002-0.004	-	0.002-0.003	0.002-0.003	0.002-0.003	0.002-0.003	-	0.002-0.003	
			2044	230	340	415	0.866-1.063	0.002-0.004	0.002-0.004	0.002-0.004	-	0.002-0.004	0.002-0.003	0.002-0.003	0.002-0.003	-	0.002-0.003	
							1.063-1.299	0.003-0.004	0.003-0.004	0.003-0.004	-	0.003-0.004	0.003-0.003	0.003-0.003	0.003-0.003	-	0.003-0.003	
							1.299-1.575	0.003-0.005	0.003-0.005	0.003-0.005	-	0.003-0.004	0.003-0.004	0.003-0.004	0.003-0.004	-	0.003-0.003	
							1.575-2.047	0.004-0.005	0.004-0.005	0.004-0.005	-	0.004-0.004	0.004-0.004	0.004-0.004	0.004-0.004	-	0.004-0.003	
				2.047-2.559	0.004-0.005	0.004-0.005	0.004-0.005	-	0.004-0.004	0.004-0.004	0.004-0.004	0.004-0.004	-	0.004-0.003				
M1.0.ZAQ	Austenitic stainless steel Annealed/quenched	200	4334	375	550	665	0.591-0.709	0.002-0.004	0.002-0.004	0.002-0.004	-	0.002-0.003	0.002-0.003	0.002-0.003	0.002-0.003	-	0.002-0.003	
			4344	375	485	565	0.709-0.866	0.002-0.004	0.002-0.004	0.002-0.004	-	0.002-0.004	0.002-0.003	0.002-0.003	0.002-0.003	-	0.002-0.003	
			2044	375	465	530	0.866-1.063	0.002-0.004	0.002-0.004	0.002-0.004	-	0.002-0.004	0.002-0.004	0.002-0.004	0.002-0.004	-	0.002-0.003	
							1.063-1.299	0.003-0.005	0.003-0.005	0.003-0.005	-	0.003-0.004	0.003-0.004	0.003-0.004	0.003-0.004	-	0.003-0.004	
							1.299-1.575	0.003-0.005	0.003-0.005	0.003-0.005	-	0.003-0.005	0.003-0.004	0.003-0.004	0.003-0.004	-	0.003-0.004	
							1.575-2.047	0.004-0.005	0.004-0.005	0.004-0.005	-	0.004-0.005	0.004-0.004	0.004-0.004	0.004-0.004	-	0.004-0.004	
				2.047-2.559	0.004-0.005	0.004-0.005	0.004-0.005	-	0.004-0.005	0.004-0.004	0.004-0.004	0.004-0.004	-	0.004-0.004				
M	M1.1.ZAQ	Austenitic stainless steel Machinability improved	200	4334	375	575	705	0.591-0.709	0.002-0.004	0.002-0.004	0.002-0.004	-	0.002-0.003	0.002-0.003	0.002-0.003	0.002-0.003	-	0.002-0.003
				4344	375	520	620	0.709-0.866	0.002-0.004	0.002-0.004	0.002-0.004	-	0.002-0.004	0.002-0.003	0.002-0.003	0.002-0.003	-	0.002-0.003
				2044	375	500	590	0.866-1.063	0.002-0.004	0.002-0.004	0.002-0.004	-	0.002-0.004	0.002-0.004	0.002-0.004	0.002-0.004	-	0.002-0.003
								1.063-1.299	0.003-0.005	0.003-0.005	0.003-0.005	-	0.003-0.004	0.003-0.004	0.003-0.004	0.003-0.004	-	0.003-0.004
								1.299-1.575	0.003-0.005	0.003-0.005	0.003-0.005	-	0.003-0.005	0.003-0.004	0.003-0.004	0.003-0.004	-	0.003-0.004
								1.575-2.047	0.004-0.005	0.004-0.005	0.004-0.005	-	0.004-0.005	0.004-0.004	0.004-0.004	0.004-0.004	-	0.004-0.004
					2.047-2.559	0.004-0.005	0.004-0.005	0.004-0.005	-	0.004-0.005	0.004-0.004	0.004-0.004	0.004-0.004	-	0.004-0.004			
	M2.0.ZAQ	Super austenitic (Ni>20%) stainless steel Annealed/quenched	200	4334	260	370	440	0.591-0.709	0.002-0.004	0.002-0.004	0.002-0.004	-	0.002-0.003	0.002-0.003	0.002-0.003	0.002-0.003	-	0.002-0.003
				4344	260	325	370	0.709-0.866	0.002-0.004	0.002-0.004	0.002-0.004	-	0.002-0.004	0.002-0.003	0.002-0.003	0.002-0.003	-	0.002-0.003
				2044	260	325	370	0.866-1.063	0.002-0.004	0.002-0.004	0.002-0.004	-	0.002-0.004	0.002-0.004	0.002-0.004	0.002-0.004	-	0.002-0.003
								1.063-1.299	0.003-0.005	0.003-0.005	0.003-0.005	-	0.003-0.004	0.003-0.004	0.003-0.004	0.003-0.004	-	0.003-0.004
								1.299-1.575	0.003-0.005	0.003-0.005	0.003-0.005	-	0.003-0.005	0.003-0.004	0.003-0.004	0.003-0.004	-	0.003-0.004
							1.575-2.047	0.004-0.005	0.004-0.005	0.004-0.005	-	0.004-0.005	0.004-0.004	0.004-0.004	0.004-0.004	-	0.004-0.004	
				2.047-2.559	0.004-0.005	0.004-0.005	0.004-0.005	-	0.004-0.005	0.004-0.004	0.004-0.004	0.004-0.004	-	0.004-0.004				
M3.1.ZAQ	Duplex stainless steel >60% ferrite (N<0.10%)	230	4334	280	365	430	0.591-0.709	0.002-0.004	0.002-0.004	0.002-0.004	-	0.002-0.003	0.002-0.003	0.002-0.003	0.002-0.003	-	0.002-0.003	
			4344	280	340	385	0.709-0.866	0.002-0.004	0.002-0.004	0.002-0.004	-	0.002-0.004	0.002-0.003	0.002-0.003	0.002-0.003	-	0.002-0.003	
			2044	280	330	370	0.866-1.063	0.002-0.004	0.002-0.004	0.002-0.004	-	0.002-0.004	0.002-0.004	0.002-0.004	0.002-0.004	-	0.002-0.003	
							1.063-1.299	0.003-0.005	0.003-0.005	0.003-0.005	-	0.003-0.004	0.003-0.004	0.003-0.004	0.003-0.004	-	0.003-0.004	
							1.299-1.575	0.003-0.005	0.003-0.005	0.003-0.005	-	0.003-0.005	0.003-0.004	0.003-0.004	0.003-0.004	-	0.003-0.004	
							1.575-2.047	0.004-0.005	0.004-0.005	0.004-0.005	-	0.004-0.005	0.004-0.004	0.004-0.004	0.004-0.004	-	0.004-0.004	
				2.047-2.559	0.004-0.005	0.004-0.005	0.004-0.005	-	0.004-0.005	0.004-0.004	0.004-0.004	0.004-0.004	-	0.004-0.004				
M3.2.ZAQ	Duplex stainless steel <60% ferrite (N≥0.10%)	260	4334	245	310	355	0.591-0.709	0.002-0.004	0.002-0.004	0.002-0.004	-	0.002-0.003	0.002-0.003	0.002-0.003	0.002-0.003	-	0.002-0.003	
			4344	245	295	340	0.709-0.866	0.002-0.004	0.002-0.004	0.002-0.004	-	0.002-0.004	0.002-0.003	0.002-0.003	0.002-0.003	-	0.002-0.003	
			2044	245	295	340	0.866-1.063	0.002-0.004	0.002-0.004	0.002-0.004	-	0.002-0.004	0.002-0.004	0.002-0.004	0.002-0.004	-	0.002-0.003	
							1.063-1.299	0.003-0.005	0.003-0.005	0.003-0.005	-	0.003-0.004	0.003-0.004	0.003-0.004	0.003-0.004	-	0.003-0.004	
							1.299-1.575	0.003-0.005	0.003-0.005	0.003-0.005	-	0.003-0.005	0.003-0.004	0.003-0.004	0.003-0.004	-	0.003-0.004	
							1.575-2.047	0.004-0.005	0.004-0.005	0.004-0.005	-	0.004-0.005	0.004-0.004	0.004-0.004	0.004-0.004	-	0.004-0.004	
				2.047-2.559	0.004-0.005	0.004-0.005	0.004-0.005	-	0.004-0.005	0.004-0.004	0.004-0.004	0.004-0.004	-	0.004-0.004				
S	S2.0.ZAN S2.0.ZAG S2.0.ZNS	Heat resistant super alloys Ni based	350	4334	65	115	150	0.591-0.709	0.002-0.003	0.002-0.003	0.002-							

CoroDrill® DS20

6-7xD

Inch values

ISO	MC No.	Material	HB	Grade	Cutting speed recommendations			Drill diameter	Drill length 6xD					Drill length 7xD				
					6-7xD	-S5W	-L5W		-L6W	-M7W	-H5W	-S5W	-L5W	-L6W	-M7W	-H5W		
						Recommended start value at middle of feed range					Recommended start value at middle of feed range							
K	K1.1.C.NS	Malleable cast iron Low tensile strength	200	4324	460	615	725	0.591-0.709	-	0.003-0.004	0.003-0.004	0.003-0.005	-	-	0.003-0.003	0.003-0.003	0.003-0.004	-
				4334	360	495	590	0.709-0.866	-	0.003-0.005	0.003-0.005	0.003-0.006	-	-	0.003-0.004	0.003-0.004	0.003-0.005	-
				4344	590	485	460	0.866-1.063	-	0.003-0.005	0.003-0.005	0.003-0.007	-	-	0.003-0.005	0.003-0.005	0.003-0.006	-
			1.063-1.299	-	0.004-0.006	0.004-0.006	0.004-0.007	-	-	0.004-0.005	0.004-0.005	0.004-0.006	-	-	0.004-0.005	0.004-0.005	0.004-0.006	-
			1.299-1.575	-	0.004-0.007	0.004-0.007	0.004-0.008	-	-	0.004-0.006	0.004-0.006	0.004-0.007	-	-	0.004-0.006	0.004-0.006	0.004-0.007	-
			1.575-2.047	-	0.005-0.007	0.005-0.007	0.005-0.008	-	-	0.005-0.006	0.005-0.006	0.005-0.007	-	-	0.005-0.006	0.005-0.006	0.005-0.007	-
	2.047-2.559	-	0.005-0.007	0.005-0.007	0.005-0.008	-	-	0.005-0.006	0.005-0.006	0.005-0.007	-	-	0.005-0.006	0.005-0.006	0.005-0.007	-		
	K2.1.C.UT	Grey cast iron Low tensile strength	180	4324	690	840	960	0.591-0.709	-	0.003-0.004	0.003-0.004	0.003-0.005	-	-	0.003-0.003	0.003-0.003	0.003-0.004	-
				4334	560	695	795	0.709-0.866	-	0.003-0.005	0.003-0.005	0.003-0.006	-	-	0.003-0.004	0.003-0.004	0.003-0.005	-
				4344	425	525	605	0.866-1.063	-	0.003-0.005	0.003-0.005	0.003-0.007	-	-	0.003-0.005	0.003-0.005	0.003-0.006	-
			1.063-1.299	-	0.004-0.006	0.004-0.006	0.004-0.007	-	-	0.004-0.005	0.004-0.005	0.004-0.006	-	-	0.004-0.005	0.004-0.005	0.004-0.006	-
			1.299-1.575	-	0.004-0.007	0.004-0.007	0.004-0.008	-	-	0.004-0.006	0.004-0.006	0.004-0.007	-	-	0.004-0.006	0.004-0.006	0.004-0.007	-
			1.575-2.047	-	0.005-0.007	0.005-0.007	0.005-0.008	-	-	0.005-0.006	0.005-0.006	0.005-0.007	-	-	0.005-0.006	0.005-0.006	0.005-0.007	-
	2.047-2.559	-	0.005-0.007	0.005-0.007	0.005-0.008	-	-	0.005-0.006	0.005-0.006	0.005-0.007	-	-	0.005-0.006	0.005-0.006	0.005-0.007	-		
	K2.2.C.UT	Grey cast iron High tensile strength	245	4324	410	600	725	0.591-0.709	-	0.003-0.003	0.003-0.003	0.003-0.005	-	-	0.003-0.003	0.003-0.003	0.003-0.004	-
				4334	330	475	575	0.709-0.866	-	0.003-0.004	0.003-0.004	0.003-0.005	-	-	0.003-0.003	0.003-0.003	0.003-0.005	-
				4344	245	365	440	0.866-1.063	-	0.003-0.005	0.003-0.005	0.003-0.006	-	-	0.003-0.004	0.003-0.004	0.003-0.005	-
			1.063-1.299	-	0.004-0.006	0.004-0.006	0.004-0.007	-	-	0.004-0.005	0.004-0.005	0.004-0.006	-	-	0.004-0.005	0.004-0.005	0.004-0.006	-
			1.299-1.575	-	0.004-0.006	0.004-0.006	0.004-0.008	-	-	0.004-0.005	0.004-0.005	0.004-0.006	-	-	0.004-0.005	0.004-0.005	0.004-0.006	-
			1.575-2.047	-	0.005-0.006	0.005-0.006	0.005-0.008	-	-	0.005-0.005	0.005-0.005	0.005-0.006	-	-	0.005-0.005	0.005-0.005	0.005-0.006	-
	2.047-2.559	-	0.005-0.006	0.005-0.006	0.005-0.008	-	-	0.005-0.005	0.005-0.005	0.005-0.006	-	-	0.005-0.005	0.005-0.005	0.005-0.006	-		
	K3.1.C.UT	Nodular cast iron Ferritic	155	4324	410	565	665	0.591-0.709	-	0.003-0.003	0.003-0.003	0.003-0.005	-	-	0.003-0.003	0.003-0.003	0.003-0.004	-
				4334	330	460	545	0.709-0.866	-	0.003-0.004	0.003-0.004	0.003-0.005	-	-	0.003-0.003	0.003-0.003	0.003-0.005	-
				4344	260	360	430	0.866-1.063	-	0.003-0.005	0.003-0.005	0.003-0.006	-	-	0.003-0.004	0.003-0.004	0.003-0.005	-
1.063-1.299			-	0.004-0.006	0.004-0.006	0.004-0.007	-	-	0.004-0.005	0.004-0.005	0.004-0.006	-	-	0.004-0.005	0.004-0.005	0.004-0.006	-	
1.299-1.575			-	0.004-0.006	0.004-0.006	0.004-0.008	-	-	0.004-0.005	0.004-0.005	0.004-0.006	-	-	0.004-0.005	0.004-0.005	0.004-0.006	-	
1.575-2.047			-	0.005-0.006	0.005-0.006	0.005-0.008	-	-	0.005-0.005	0.005-0.005	0.005-0.006	-	-	0.005-0.005	0.005-0.005	0.005-0.006	-	
2.047-2.559	-	0.005-0.006	0.005-0.006	0.005-0.008	-	-	0.005-0.005	0.005-0.005	0.005-0.006	-	-	0.005-0.005	0.005-0.005	0.005-0.006	-			
K3.3.C.UT	Nodular cast iron Ferritic	265	4324	360	520	620	0.591-0.709	-	0.003-0.003	0.003-0.003	0.003-0.005	-	-	0.003-0.003	0.003-0.003	0.003-0.004	-	
			4334	295	430	520	0.709-0.866	-	0.003-0.004	0.003-0.004	0.003-0.005	-	-	0.003-0.003	0.003-0.003	0.003-0.005	-	
			4344	230	320	385	0.866-1.063	-	0.003-0.005	0.003-0.005	0.003-0.006	-	-	0.003-0.004	0.003-0.004	0.003-0.005	-	
		1.063-1.299	-	0.004-0.006	0.004-0.006	0.004-0.007	-	-	0.004-0.005	0.004-0.005	0.004-0.006	-	-	0.004-0.005	0.004-0.005	0.004-0.006	-	
		1.299-1.575	-	0.004-0.006	0.004-0.006	0.004-0.008	-	-	0.004-0.005	0.004-0.005	0.004-0.006	-	-	0.004-0.005	0.004-0.005	0.004-0.006	-	
		1.575-2.047	-	0.005-0.006	0.005-0.006	0.005-0.008	-	-	0.005-0.005	0.005-0.005	0.005-0.006	-	-	0.005-0.005	0.005-0.005	0.005-0.006	-	
2.047-2.559	-	0.005-0.006	0.005-0.006	0.005-0.008	-	-	0.005-0.005	0.005-0.005	0.005-0.006	-	-	0.005-0.005	0.005-0.005	0.005-0.006	-			
K4.2.C.UT	Compacted graphite iron High tensile strength	230	4324	425	610	740	0.591-0.709	-	0.003-0.003	0.003-0.003	0.003-0.005	-	-	0.003-0.003	0.003-0.003	0.003-0.004	-	
			4334	360	495	590	0.709-0.866	-	0.003-0.004	0.003-0.004	0.003-0.005	-	-	0.003-0.003	0.003-0.003	0.003-0.005	-	
			4344	280	375	440	0.866-1.063	-	0.003-0.005	0.003-0.005	0.003-0.006	-	-	0.003-0.004	0.003-0.004	0.003-0.005	-	
		1.063-1.299	-	0.004-0.006	0.004-0.006	0.004-0.007	-	-	0.004-0.005	0.004-0.005	0.004-0.006	-	-	0.004-0.005	0.004-0.005	0.004-0.006	-	
		1.299-1.575	-	0.004-0.006	0.004-0.006	0.004-0.008	-	-	0.004-0.005	0.004-0.005	0.004-0.006	-	-	0.004-0.005	0.004-0.005	0.004-0.006	-	
		1.575-2.047	-	0.005-0.006	0.005-0.006	0.005-0.008	-	-	0.005-0.005	0.005-0.005	0.005-0.006	-	-	0.005-0.005	0.005-0.005	0.005-0.006	-	
2.047-2.559	-	0.005-0.006	0.005-0.006	0.005-0.008	-	-	0.005-0.005	0.005-0.005	0.005-0.006	-	-	0.005-0.005	0.005-0.005	0.005-0.006	-			
H	H1.3.Z.HA Extra hard steel Hardened and tempered	60 (HRC)	4324	100	195	250	0.591-0.709	-	0.002-0.003	0.002-0.003	0.002-0.003	-	-	0.002-0.003	0.002-0.003	0.002-0.003	-	
			4334	100	195	250	0.709-0.866	-	0.002-0.004	0.002-0.004	0.002-0.004	-	-	0.002-0.003	0.002-0.003	0.002-0.003	-	
			4344	100	195	250	0.866-1.063	-	0.002-0.004	0.002-0.004	0.002-0.004	-	-	0.002-0.003	0.002-0.003	0.002-0.003	-	
		1.063-1.299	-	0.003-0.004	0.003-0.004	0.003-0.004	-	-	0.003-0.003	0.003-0.003	0.003-0.003	-	-	0.003-0.003	0.003-0.003	0.003-0.003	-	
		1.299-1.575	-	0.003-0.005	0.003-0.005	0.003-0.005	-	-	0.003-0.004	0.003-0.004	0.003-0.004	-	-	0.003-0.004	0.003-0.004	0.003-0.004	-	
		1.575-2.047	-	0.004-0.005	0.004-0.005	0.004-0.005	-	-	0.004-0.004	0.004-0.004	0.004-0.004	-	-	0.004-0.004	0.004-0.004	0.004-0.004	-	
2.047-2.559	-	0.004-0.005	0.004-0.005	0.004-0.005	-	-	0.004-0.004	0.004-0.005	0.004-0.005	-	-	0.004-0.004	0.004-0.004	0.004-0.004	-			

Feed at hole entry should be 75% of recommended feed rate. Feed at hole exit, use 0.002 inch/rev.

CoroDrill® DS20

6-7xD

Inch values

ISO	MC No.	Material	HB	Grade	Cutting speed recommendations			Drill diameter	Drill length 6xD					Drill length 7xD				
									-S5W	-L5W	-L6W	-M7W	-H5W	-S5W	-L5W	-L6W	-M7W	-H5W
					6-7xD				Recommended start value at middle of feed range									
N	N1.2.ZAG	Aluminium based alloys	100	H13A 4344	985	1075	1180	0.591-0.709	0.002-0.004	0.002-0.004	0.002-0.004	-	-	0.002-0.003	0.002-0.003	0.002-0.003	-	-
					985	1075	1180	0.709-0.866	0.002-0.005	0.002-0.005	0.002-0.005	-	-	0.002-0.004	0.002-0.004	0.002-0.004	-	-
		AISI alloys, Si ≤ 1%	0.866-1.063	0.002-0.005	0.002-0.005	0.002-0.005	-	-	0.002-0.004	0.002-0.004	0.002-0.004	-	-	-	-			
			1.063-1.299	0.003-0.006	0.003-0.006	0.003-0.006	-	-	0.003-0.005	0.003-0.005	0.003-0.005	-	-	-	-			
			1.299-1.575	0.003-0.006	0.003-0.006	0.003-0.006	-	-	0.003-0.005	0.003-0.005	0.003-0.005	-	-	-	-			
			1.575-2.047	0.004-0.006	0.004-0.006	0.004-0.006	-	-	0.004-0.005	0.004-0.005	0.004-0.005	-	-	-	-			
	2.047-2.559	0.004-0.006	0.004-0.006	0.004-0.006	-	-	0.004-0.005	0.004-0.005	0.004-0.005	-	-	-	-					
	N1.3.C.UT	Aluminium based alloys	75	H13A 4344	820	1025	1180	0.591-0.709	0.002-0.004	0.002-0.004	0.002-0.004	-	-	0.002-0.003	0.002-0.003	0.002-0.003	-	-
					820	1025	1180	0.709-0.866	0.002-0.004	0.002-0.004	0.002-0.004	-	-	0.002-0.003	0.002-0.003	0.002-0.003	-	-
		AISI alloys, Si ≤ 1%	0.866-1.063	0.002-0.005	0.002-0.005	0.002-0.005	-	-	0.002-0.004	0.002-0.004	0.002-0.004	-	-	-	-			
			1.063-1.299	0.003-0.005	0.003-0.005	0.003-0.005	-	-	0.003-0.004	0.003-0.004	0.003-0.004	-	-	-	-			
			1.299-1.575	0.003-0.006	0.003-0.006	0.003-0.006	-	-	0.003-0.005	0.003-0.005	0.003-0.005	-	-	-	-			
			1.575-2.047	0.004-0.006	0.004-0.006	0.004-0.006	-	-	0.004-0.005	0.004-0.005	0.004-0.005	-	-	-	-			
	2.047-2.559	0.004-0.006	0.004-0.006	0.004-0.006	-	-	0.004-0.005	0.004-0.005	0.004-0.005	-	-	-	-					
	N1.3.C.AG	Aluminium based alloys	90	H13A 4344	820	930	1035	0.591-0.709	0.002-0.004	0.002-0.004	0.002-0.004	-	-	0.002-0.003	0.002-0.003	0.002-0.003	-	-
					820	930	1035	0.709-0.866	0.002-0.004	0.002-0.004	0.002-0.004	-	-	0.002-0.003	0.002-0.003	0.002-0.003	-	-
		AISI cast and aged alloys (1% < Si < 13%)	0.866-1.063	0.002-0.005	0.002-0.005	0.002-0.005	-	-	0.002-0.004	0.002-0.004	0.002-0.004	-	-	-	-			
			1.063-1.299	0.003-0.005	0.003-0.005	0.003-0.005	-	-	0.003-0.004	0.003-0.004	0.003-0.004	-	-	-	-			
			1.299-1.575	0.003-0.006	0.003-0.006	0.003-0.006	-	-	0.003-0.005	0.003-0.005	0.003-0.005	-	-	-	-			
			1.575-2.047	0.004-0.006	0.004-0.006	0.004-0.006	-	-	0.004-0.005	0.004-0.005	0.004-0.005	-	-	-	-			
	2.047-2.559	0.004-0.006	0.004-0.006	0.004-0.006	-	-	0.004-0.005	0.004-0.005	0.004-0.005	-	-	-	-					
	N3.3.U.UT	Copper based alloys	110	H13A 4344	820	1025	1180	0.591-0.709	0.002-0.004	0.002-0.004	0.002-0.004	-	-	0.002-0.003	0.002-0.003	0.002-0.003	-	-
					820	1025	1180	0.709-0.866	0.002-0.005	0.002-0.005	0.002-0.005	-	-	0.002-0.004	0.002-0.004	0.002-0.004	-	-
		Free cutting copper based alloys	0.866-1.063	0.002-0.005	0.002-0.005	0.002-0.005	-	-	0.002-0.004	0.002-0.004	0.002-0.004	-	-	-	-			
1.063-1.299			0.003-0.006	0.003-0.006	0.003-0.006	-	-	0.003-0.005	0.003-0.005	0.003-0.005	-	-	-	-				
1.299-1.575			0.003-0.006	0.003-0.006	0.003-0.006	-	-	0.003-0.005	0.003-0.005	0.003-0.005	-	-	-	-				
1.575-2.047			0.004-0.006	0.004-0.006	0.004-0.006	-	-	0.004-0.005	0.004-0.005	0.004-0.005	-	-	-	-				
2.047-2.559	0.004-0.006	0.004-0.006	0.004-0.006	-	-	0.004-0.005	0.004-0.005	0.004-0.005	-	-	-	-						
N3.2.C.UT	Copper based alloys	90	H13A 4344	590	645	705	0.591-0.709	0.002-0.004	0.002-0.004	0.002-0.004	-	-	0.002-0.003	0.002-0.003	0.002-0.003	-	-	
				590	645	705	0.709-0.866	0.002-0.005	0.002-0.005	0.002-0.005	-	-	0.002-0.004	0.002-0.004	0.002-0.004	-	-	
	Leaded brass & bronzes (Pb ≤ 1%)	0.866-1.063	0.002-0.005	0.002-0.005	0.002-0.005	-	-	0.002-0.004	0.002-0.004	0.002-0.004	-	-	-	-				
		1.063-1.299	0.003-0.006	0.003-0.006	0.003-0.006	-	-	0.003-0.005	0.003-0.005	0.003-0.005	-	-	-	-				
		1.299-1.575	0.003-0.006	0.003-0.006	0.003-0.006	-	-	0.003-0.005	0.003-0.005	0.003-0.005	-	-	-	-				
		1.575-2.047	0.004-0.006	0.004-0.006	0.004-0.006	-	-	0.004-0.005	0.004-0.005	0.004-0.005	-	-	-	-				
2.047-2.559	0.004-0.006	0.004-0.006	0.004-0.006	-	-	0.004-0.005	0.004-0.005	0.004-0.005	-	-	-	-						

Feed at hole entry should be 75% of recommended feed rate. Feed at hole exit, use 0.002 inch/rev.

Selecting your cutting data

Chip formation and chip evacuation are critical issues in drilling and depend on the workpiece material, choice of drill/insert geometry, coolant pressure/volume and cutting data. Chip jamming can cause radial movement of the drill and consequently affect hole quality, drill life and reliability or drill/insert breakages.

Chip formation is acceptable when the chips can be evacuated from the drill without disturbance. The best way to identify this is to listen during drilling. A consistent sound means that chip evacuation is good, but an interrupted sound indicates chip jamming. Check the feed force or power monitor. If there are irregularities, chip jamming could be the reason. Look at the chips: if they are long and bent, instead of curled, chip jamming has occurred. Look at the hole: if chip jamming has occurred, an uneven surface will be visible

Effects of cutting speed – v_c

Cutting speed that is too high:

Rapid flank wear
Plastic deformation
Poor hole quality and bad hole tolerance

Cutting speed that is too low:

Built-up edge
Bad chip evacuation
Longer time in cut

Effects of feed – f_n

High feed rate:

Harder chip breaking
Less time in cut
Less tool wear but increased risk for drill breakages
Reduced hole quality

Low feed rate:

Preferable for long-chipping materials
Quality improvement
Accelerated tool wear
Longer time in cut

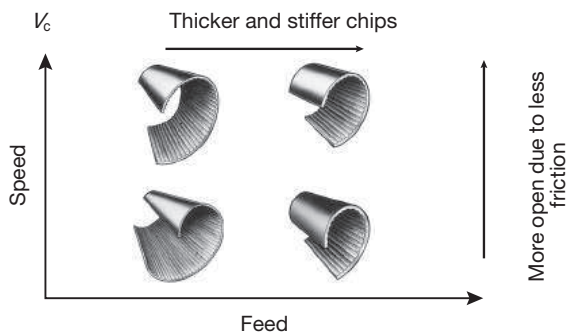

Achieving good hole quality

Chip evacuation

Make sure chip evacuation is satisfactory. Chip jamming affects hole quality and reliability/tool life. Drill/insert geometry and cutting data are crucial.

Stability, tool set-up

Use the shortest possible drill. Use a rigid and accurate tool holder with minimum run-out. Make sure the machine spindle is in good condition and is well-aligned. Ensure that the component is fixed and stable. Establish correct feed rates for irregular, angular surfaces and cross holes.

Tool life

Check insert wear and establish a predetermined tool life program. The most effective way to supervise drilling is by using a feed force monitor.

Maintenance

Change the insert-clamping screw regularly. Clean the tip seat before changing the insert, and make sure to use a torque wrench. Don't exceed maximum wear before regrinding solid carbide drills.

Drilling deep holes with CoroDrill® DS20

If best possible hole quality is needed when drilling 6-7xD holes with CoroDrill DS20, it is important to utilize a reduced feed rate at the entry (first 1-2 mm) (.039-.787 inch) and exit (last 5 mm) (.197 inch).

Boring

Rough boring

CoroBore® 111 inserts for rough boring

D2

For complete assortment, see www.sandvik.coromant.com

CoroBore® 111 inserts for rough boring

S-style insert (Square)

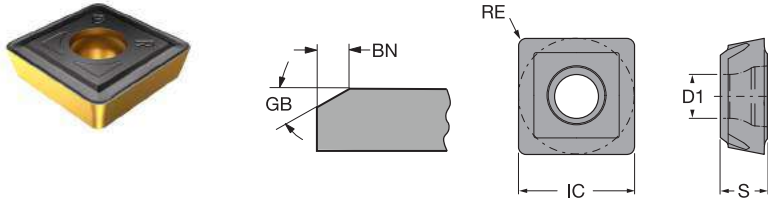

B

										P	
										4425	
		S	RE	BSR	GB	BN	ISO CODE			★	
Roughing	BR	06	2.60	0.60	5.0	5°	0.10	SPMT0606-BR			★
			.102	.024	.197	5°	.004				
		08	3.00	0.80	5.0	5°	0.10	SPMT0808-BR			★
			.118	.031	.197	5°	.004				
		12	4.00	1.20	5.0	5°	0.15	SPMT1212-BR			★
			.157	.047	.197	5°	.006				
		18	5.50	1.20	5.0	5°	0.15	SPMT1812-BR			★
			.217	.047	.197	5°	.006				

C

D

E

F



F2

Rotating tool adaptors

Machine side interface Coromant Capto®

Coromant Capto® to MDI adaptor

E2

Machine side interface HSK

HSK to MDI adaptor

E3

For complete assortment, see www.sandvik.coromant.com

A

Coromant Capto® to MDI adaptor

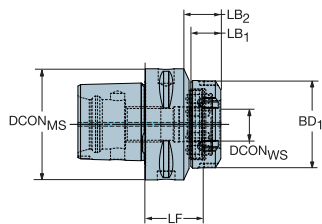

B

Dimensions, mm, inch

CZC _{MS}	CZC _{WS}	CNSC	CXSC	Ordering code	DCON _{MS}	DCON _{WS}	LF	LB ₁	LB ₂	BD ₁	BAR PSI	NM	KG	RPMX
C8	MDI-25	3	1	C8-DM25-N-042	80.0	25.0	42.0	17.0	52.0	62.7	80	170.0	2.08	14000
					3.150	.984	1.654	.669	2.047	2.469	1160			

For spare parts, visit www.sandvik.coromant.com

C

D

E

F



F2



F5

HSK to MDI adaptor

Machine side interface HSK A/C/T



DSGN

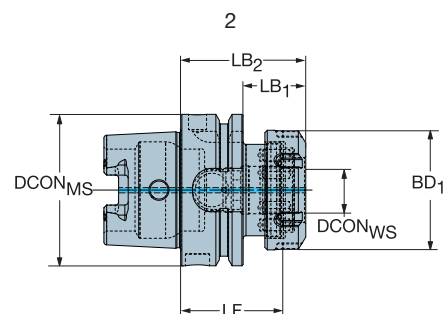
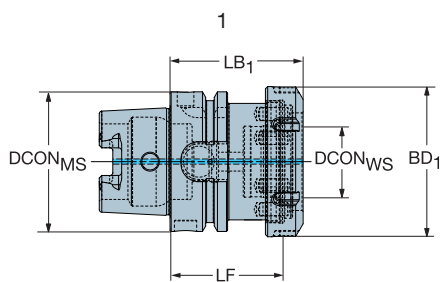

Metric bore

					Dimensions, mm, inch											
CZC _{MS}	CZC _{WS}	CNSC	CXSC	DSGN	Ordering code	DCON _{MS}	DCON _{WS}	LF	LB ₁	LB ₂	BD ₁	BD ₂	BAR PSI	NM	KG	RPMX
63.0	MDI-40	1	1	1	HT06-DM40-N-061	63.0	40.0	61.0	73.0	79.7	80	230.0	1.51	20500		
						<i>2.480</i>	<i>1.575</i>	<i>2.402</i>	<i>2.874</i>	<i>3.138</i>	<i>1160</i>					
100.0	MDI-25	1	1	2	HT10-DM25-N-048	100.0	25.0	48.0	29.0	58.0	62.7	100.0	80	170.0	2.37	12500
						<i>3.937</i>	<i>.984</i>	<i>1.890</i>	<i>1.142</i>	<i>2.283</i>	<i>2.469</i>	<i>3.937</i>	<i>1160</i>			
	MDI-32	1	1	2	HT10-DM32-N-048	100.0	32.0	48.0	29.0	58.0	67.7	100.0	80	200.0	2.40	12500
						<i>3.937</i>	<i>1.260</i>	<i>1.890</i>	<i>1.142</i>	<i>2.283</i>	<i>2.665</i>	<i>3.937</i>	<i>1160</i>			
	MDI-40	1	1	2	HT10-DM40-N-048	100.0	40.0	48.0	31.0	60.0	79.7	100.0	80	230.0	2.60	12500
						<i>3.937</i>	<i>1.575</i>	<i>1.890</i>	<i>1.220</i>	<i>2.362</i>	<i>3.138</i>	<i>3.937</i>	<i>1160</i>			
	MDI-50	1	1	2	HT10-DM50-N-055	100.0	50.0	55.0	40.0	69.0	94.7	100.0	80	250.0	3.15	12500
						<i>3.937</i>	<i>1.969</i>	<i>2.165</i>	<i>1.575</i>	<i>2.717</i>	<i>3.728</i>	<i>3.937</i>	<i>1160</i>			

For spare parts, visit www.sandvik.coromant.com

F2



F5

General information

ISO 13399	F2
Coolant supply information	F5
Reconditioning	F6
Safety information	F7
Coromant Recycling Concept (CRC)	F8

ISO 13399 is an international standard that strives to simplify the exchange of data for cutting tools. You will notice a slight difference through the new parameters and descriptions of each tool.

For the first time ever, there is a standardized way of describing product data regarding cutting tools. When all tools in the industry share the same parameters and definitions, communicating tool information becomes very straightforward.

B What does this mean to you?

Basically, it means that your systems can talk to ours, as they all speak the same language. Download product data from our web site and use it directly in your CAD/CAM software to assemble tools that you use in production. No need to look for information in catalogues and interpret data from one system to another. Imagine how much time this will save you!

Short name	Preferred Name
ADJLN	Minimum adjustment limit
ADJLX	Maximum adjustment limit
ADJRG	Adjustment range
ALP	Clearance angle axial
AN	Clearance angle major
ANN	Clearance angle minor
APMX	Depth of cut maximum
APMX_EFW	Depth of cut maximum - end feed
APMX_FFW	Depth of cut maximum - side feed
AZ	Maximum plunge depth
B	Shank width
BAWS	Body angle workpiece side
BAMS	Body angle machine side
BBD	Balanced by design
BBR	Balanced by rotational test
BCH	Corner chamfer length
BD	Body diameter
BHTA	Body half taper angle
BN	Face land width
BS	Wiper edge length
BSG	Basic standard group
BSR	Wiper edge radius
CBMD	Chip breaker manufacturer
CDX	Cutting depth maximum
CEMR	Cutting edge major radius
CF	Spot chamfer
CHBA	Chamfer body angle
CHBL	Chamfer body length
CHW	Corner chamfer width
CICT	Cutting item count
CICT _{BALL}	Cutting item count - Ball nose insert
CICT _E	Cutting item count - end position
CICT _P	Cutting item count - peripheral position
CICT _S	Cutting item count - side position
CICT _{SP}	Cutting item count - Shank protection insert
CICT _T	Cutting item count - total
CND	Coolant entry diameter
CNSC	Coolant entry style code
CNT	Coolant entry thread size
COATING	Coating
CP	Max coolant pressure
CRKS	Connection retention knob thread size
CRNT	Coolant radial entry thread size
CTPT	Operation type
CUTDIA	Work piece parting diameter maximum
CW	Cutting width
CWN	Minimum cutting width
CWTOLL	Cutting width lower tolerance
CWTOLU	Cutting width upper tolerance
CWX	Cutting width maximum
CXSC	Coolant exit style code
CZC	Connection size code
CZC _{MS}	Connection size code machine side
CZC _{WS}	Connection size code workpiece side
D1	Fixing hole diameter
DAH	Diameter access hole
DAXIN	Axial groove inside diameter minimum
DAXN	Minimum axial groove outside diameter

DAXX	Axial groove outside diameter maximum
DBC	Diameter bolt circle
DC	Cutting diameter
DCB	Connection bore diameter
DCBN	Connection bore diameter minimum
DCBX	Connection bore diameter maximum
DCF	Cutting diameter face contact
DCIN	Cutting diameter internal
DCN	Cutting diameter minimum
DCON	Connection diameter
DCON _{MS}	Connection diameter machine side
DCON _{WS}	Connection diameter workpiece side
DCONN _{WS}	Connection diameter minimum workpiece side
DCONX _{WS}	Connection diameter maximum workpiece side
DCPS	Data chip provision size
DCSF _{MS}	Contact surface diameter machine side
DCSF _{WS}	Contact surface diameter workpiece side
DCX	Cutting diameter maximum
DHUB	Hub diameter
DIX	Tool changer interference diameter maximum
DMIN	Minimum bore diameter
DMM	Shank diameter
DN	Neck diameter
DRVCT	Drive count
DSGN	Design
EPSR	Insert included angle
FHA	Flute helix angle
FLGT	Flange thickness
FTDZ	For thread diameter size
GB	Face land angle
H	Shank height
HA	Thread height theoretical
HB	Thread height difference
HBH	Head bottom offset height
HC	Thread height actual
HF	Functional height
HRY	Lowest point from reference plain
HSUP	Support height
HTB	Body height
HTH	Height
IC	Inscribed circle diameter
INSL	Insert length
INSUC	Insert usage code
IZC	Insert size code
KAPR	Tool cutting edge angle
KAPR_EFW	Tool cutting edge angle - end feed
KCH	Corner chamfer
KRINS	Major cutting edge angle
KWW	Keyway width
L	Cutting edge length
LAMS	Inclination angle
LB	Body length
LCF	Length chip flute
LCOX	Cut off length maximum
LE	Cutting edge effective length
LF	Functional length
LFN	Minimum functional length
LH	Head length
LPR	Protruding length
LS	Shank length
LSC	Clamping length
LSCN	Clamping length minimum
LSCS	Distance to clamping start
LSCX	Clamping length maximum
LSD	Dead shank length
LU	Usable length (max. recommended)
LU_BFW	Usable length - back facing
LUX	Usable length maximum
MHD	Mounting hole distance
MIID	Master insert identification
MIID _E	Master insert identification - end position
MIID _S	Master insert identification - side position
MIID _C	Master insert identification - central position
MIID _P	Master insert identification - peripheral position
MIID _I	Master insert identification - intermediate position
MMCC	Code for preset torque
MMCX	Max. cutting torque
NOF	Flute count
NT	Tooth count
OAH	Overall height
OAL	Overall length
OAW	Overall width
OH	Overhang recommended
OHN	Overhang minimum

OHX	Overhang maximum
ORDCODE	Ordercode
PCL	Peripheral cylindrical length
PDX	Profile distance ex
PDY	Profile distance ey
PHD	Premachined hole diameter
PHDX	Maximum premachined hole diameter
PL	Point length
PNA	Profile included angle
PRFRAD	Profile radius
PRSPC	Profile specification
PSIR	Tool lead angle
PSIRL	Cutting edge angle major left hand
PSIRR	Cutting edge angle major right hand
PSW	Premachined slot width
RADH	Radial body height
RADW	Radial body width
RAR	Right hand relief angle
RE	Corner radius
REEQ	Corner radius equivalent
REL	Corner radius left
RER	Corner radius right
RETOLL	Corner radius lower tolerance
RETOLU	Corner radius upper tolerance
RGL	Regrind length
RMPX	Maximum ramping angle
RPMX	Rotational speed maximum
S	Insert thickness
SDL	Step diameter length
SIG	Point angle
SPTL	Splitline
SSC	Insert seat size code
SSC _E	Insert seat size code - end position
SSC _P	Insert seat size code - peripheral position
SSC _S	Insert seat size code - side position
STA	Step included angle
STDNO	Standard number
SUBSTRATE	Substrate
TCDC	Tolerance class cutting diameter
TCDCON	Connection diameter tolerance
TCDDMM	Shank diameter tolerance
TCHA	Achievable hole tolerance
TCHAL	Achievable hole tolerance lower
TCHAU	Achievable hole tolerance upper
TCT	Tolerance class tool
TCTR	Thread tolerance class
TD	Thread diameter
TDZ	Thread diameter size
TFLA	Tap floating length ahead
TFLB	Tap floating length behind
TG	Taper gradient
THBTP	Thread back taper property
THCA	Thread helix correction angle
THCHT	Threading chamfer type
THFT	Form type
THFTS	Thread form standard series
THL	Thread length
THUB	Hub thickness
TP	Thread pitch
TPI	Threads per inch
TPIN	Threads per inch minimum
TPIX	Threads per inch maximum
TPN	Thread pitch minimum
TPT	Thread profile type
TPX	Maximum thread pitch
TRMAX	Tap range max
TQ	Torque
TSYC	Tool style code
TTP	Thread type
ULDR	Usable length diameter ratio
VCX	Maximum cutting speed
W1	Insert width
WB	Body width
WF	Functional width
WFCIRP	Width to cutting item reference point
WSC	Clamping width
WT	Weight of item
ZADJ	Insert adjustable count
ZEFF	Face effective cutting edge count
ZEFP	Peripheral effective cutting edge count (ZEFP)
ZWX	Maximum number of Wiper inserts



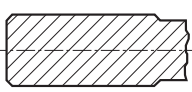
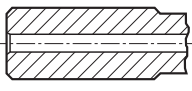
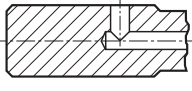
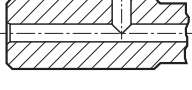
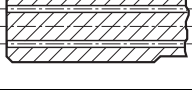
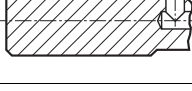
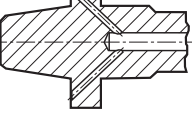
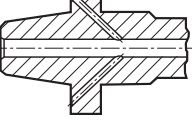
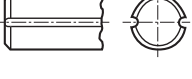

CNSC

Coolant entry style code

Code	Description	Image
0	Without coolant	
1	Axial concentric entry	
2	Radial entry	
3	Axial concentric and radial entry	
4	Axial concentric entry on circle	
5	Radial entry before adaptor	
6	Decentral over flange	
7	Decentral over flange and axial	
8	Decentral over slots on the shank	

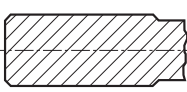
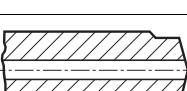
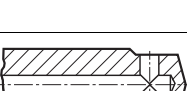
CXSC

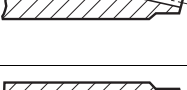
Coolant exit style code

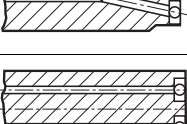
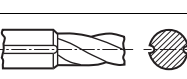
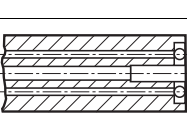
Code	Description	Image
0	No coolant exit	
1	Axial concentric exit	
2	Radial exit	
3	Axial inclined exit	
4	Axial concentric on circle	
5	Axial inclined exit with nozzle, adjustable	
6	Decentral exit with nozzle, adjustable	
7	Decentral over slots on the shank	
8	Axial or decentral with nozzle, adjustable	

Reconditioning

We offer more than just traditional "regrinding". With our reconditioning service we guarantee repeated original performance of your tools to reduce your cost per application.

Our offer



100%

Reliability

Our specialists are available for you with support and know-how.



x3

Original performance

The original tool quality is guaranteed - up to three times.



50%

Savings

With reconditioning you can reduce your tool costs up to 50%.

Products in service

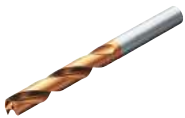

Drilling



Milling



Reaming



As indicated by the reconditioning symbol on family and product pages.

Additional information



Reconditioning box

The box can be ordered in two sizes:

- Small (300 x 200 x 138mm)

Article number: 6949557

- Medium (400 x 300 x 138mm)

Article number: 6949558

All Sandvik Coromant tool types can be shipped in same box.

Reconditioning service

- Prior to reconditioning, an inspection will determine if your tool can be reconditioned.

Non-reconditionable tools will be returned

- A laser mark on the tool shank indicates each reconditioning service performed

- The tools are delivered back in original packaging

What happens with your tools?

- Complete geometry restoration

- Drill length is reduced

- End mill diameter and length are reduced (Minimum diameter is about 0.9xDc)

- Reamer diameter tolerance is maintained

For prices contact your local Sandvik Coromant representative.

Safety information in connection with grinding of cemented carbide

Material composition

Most metal products contain tungsten carbide and cobalt. Other substances that may be present in hard metal are titanium carbide, tantalum carbide, niobium carbide, chromium carbide, molybdenum carbide or vanadium carbide. Some grades contain titanium carbonitride and/or nickel.

Routes of exposure

Grinding or heating of hard metal blanks or hard metal products will produce products that give off dangerous dust and fumes. Avoiding ingestion and contact with skin or eyes is very important.

Acute toxicity

Intake of the aforementioned substances is toxic. Inhalation may cause irritation and inflammation of the airways. Significantly higher acute inhalation toxicity has been reported during simultaneous inhalation of cobalt and tungsten carbide compared to inhalation of cobalt alone.

Skin contact can cause irritation and rash. Sensitive individuals may even experience an allergic reaction.

Chronic toxicity

Repeated inhalation of aerosols containing cobalt may cause obstruction of the airways. Prolonged exposure to increased concentrations may cause lung fibrosis or lung cancer. Epidemiological studies indicate that workers previously exposed to high concentrations of tungsten carbide/cobalt carried an increased risk of developing lung cancer.

Cobalt and nickel are potent skin sensitizers. Repeated or prolonged contact can cause irritation and sensitization.

Risk phrases

Toxic: danger of serious damage to health by prolonged exposure through inhalation

Toxic when inhaled

Limited evidence of a carcinogenic effect.

May cause sensitization by inhalation and skin contact

Preventive measures

Avoid formation and inhalation of dust. Use adequate local exhaust ventilation to keep personal exposure well below nationally authorised limits.

If ventilation is not available or adequate, use respirators appropriately approved for the purpose.

Use safety goggles or glasses with side shields when necessary.

Avoid repeated skin contact. Wear suitable gloves. Wash skin thoroughly after handling.

Use suitable protective clothing. Launder clothing if needed.

Do not eat, drink or smoke in the working area. Wash skin thoroughly before eating, drinking or smoking.

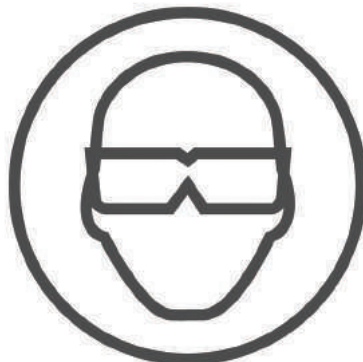

For the sake of the environment

Get into the Sandvik Coromant Recycling Concept (CRC) now!

B

The Sandvik Coromant Recycling Concept (CRC) is a comprehensive service for used carbide inserts and solid carbide tools offered by Sandvik Coromant to all its customers.

In the light of increasing consumption of non-renewable raw materials, the economic management of dwindling resources is a duty owed by all manufacturers.

Sandvik Coromant is playing its part by offering to collect used carbide inserts and solid carbide tools and recycle them in the most environmentally friendly way.

All used carbide inserts are collected in the collection box at the workplace.

When the collection box is sufficiently full, its contents are transferred to the transport box.

The full transport box is then sent to the nearest Sandvik Coromant office or to your Sandvik Coromant dealer who can also give you more information.

C

The benefits of the CRC speak for themselves

- A worldwide ISO and OHAS certified recycling system.
- Open to all Sandvik Coromant customers.
- Simple procedure with collection and transport boxes.
- Less waste, easing the burden on the environment.
- Better utilisation of resources.
- Other manufacturers' carbide inserts are also accepted.

D



E

Order collection boxes for each lathe, milling machine, drill or for your machining centre. We recommend one collection box for inserts and one separate box for solid carbide tools for each cutting workplace.

For detailed instructions on how to sell your used cemented carbide, please visit www.sandvik.coromant.com and select your market.

F

Collection box:	Order numbers
Transport box for solid carbide tools (plywood):	91617
Transport box inserts (plywood):	92994
	92995